



USER MANUAL for

- **data logger with 0/4 ÷ 20 mA inputs**
 - Loggy Soft v. 1.5.5 or higher
 - S-Toolkit v. 1.7.0 or higher

device type: **PMS-90R - 0/4..20**

firmware version: 2.10 b972 or higher



Read the user's manual carefully before starting to use the unit or software.
Producer reserves the right to implement changes without prior notice.

CONTENTS

I. USER MANUAL FOR “PMS-90R” DATA LOGGER.....	<u>4</u>
1. BASIC REQUIREMENTS AND USER SAFETY.....	<u>4</u>
2. GENERAL CHARACTERISTICS.....	<u>5</u>
3. TECHNICAL DATA.....	<u>6</u>
4. DEVICE INSTALLATION.....	<u>9</u>
4.1. UNPACKING.....	<u>9</u>
4.2. ASSEMBLY.....	<u>9</u>
4.3. CONNECTION METHOD.....	<u>12</u>
4.4. MAINTENANCE.....	<u>15</u>
5. FRONT PANEL DESCRIPTION.....	<u>16</u>
6. PRINCIPLE OF OPERATION.....	<u>17</u>
6.1. MEASUREMENT MODE.....	<u>17</u>
6.1.1. Recording momentary and averaged data.....	<u>17</u>
6.2. MODES OF RESULT PRESENTATION.....	<u>19</u>
6.2.1. "Single channel" mode.....	<u>20</u>
6.2.2. "Measurements list" mode.....	<u>21</u>
6.2.3. "Graph" mode.....	<u>24</u>
6.2.4. "Channels List" mode.....	<u>27</u>
7. DEVICE PROGRAMMING.....	<u>28</u>
7.1. PARAMETERS EDITION.....	<u>29</u>
7.1.1. Numeric and switching parameters ("LIST" - type).....	<u>29</u>
7.1.2. Text parameters.....	<u>30</u>
7.1.3. "SLIDER" - type parameters.....	<u>32</u>
7.2. DESCRIPTION OF RESULTS PRESENTATION MODES MENU.....	<u>32</u>
7.2.1. "Measurements list options" menu.....	<u>32</u>
7.2.2. "Graph options" menu.....	<u>33</u>
7.2.3. "Channels list options" menu.....	<u>34</u>
7.3. RESULTS PRESENTATION MODES MENU STRUCTURE.....	<u>35</u>
7.4. MAIN MENU DESCRIPTION.....	<u>35</u>
7.4.1. "Device information" menu.....	<u>35</u>
7.4.2. "Display options" menu.....	<u>36</u>
7.4.3. "Logging setup" menu.....	<u>37</u>
7.4.4. "Input settings" menu.....	<u>39</u>
7.4.5. "Date & time settings" menu.....	<u>41</u>
7.4.6. "RS485 port settings" menu.....	<u>42</u>
7.4.7. "Access setup" menu.....	<u>43</u>
7.4.8. "USB options" menu.....	<u>44</u>
7.4.9. "Language" parameter.....	<u>45</u>
7.5. MAIN MENU STRUCTURE.....	<u>46</u>
8. DOWNLOADING DATA FROM DATA LOGGER.....	<u>47</u>
8.1. MODBUS (RS485) DATA DOWNLOAD.....	<u>47</u>
8.2. USB FLASH DRIVE (PENDRIVE) DATA DOWNLOAD.....	<u>47</u>
9. THE MODBUS PROTOCOL HANDLING.....	<u>48</u>
9.1. LIST OF REGISTERS.....	<u>48</u>
9.2. TRANSMISSION ERRORS HANDLING.....	<u>51</u>
9.3. EXAMPLES OF QUERY/ANSWER FRAMES.....	<u>52</u>
10. USER'S SETTINGS LIST.....	<u>55</u>
II. USER MANUAL FOR “LOGGY SOFT”	<u>59</u>
1. GENERAL CHARACTERISTICS.....	<u>59</u>
2. INSTALLATION AND STARTUP.....	<u>59</u>

3. USING THE PROGRAM.....	62
3.1. „CURRENT MEASURE“ MENU.....	63
3.2. „REPORTS“ MENU.....	63
3.2.1.„Table“ tab.....	64
3.2.2.„Graph“ tab.....	66
3.3. „CONFIGURATION“ MENU.....	71
3.3.1.„Devices“ tab.....	71
3.3.2.„Groups“ tab - group operations.....	73
3.3.3.„Settings“ tab.....	75
3.4. LIST OF ERRORS AND FAULT DIAGNOSTICS	76

III. USER MANUAL FOR “S-TOOLKIT”.....77

1. GENERAL CHARACTERISTICS.....	77
2. INSTALLATION AND STARTUP.....	77
3. USING PROGRAM.....	78
3.1. “INPUTS SETTINGS” TAB.....	79
3.2. “LOGGING SETUP” TAB.....	80
3.3. “INTERFACE OPTIONS” TAB.....	81
3.4. “DEVICE INFORMATION” TAB.....	82
3.5. CONFIGURATION MODES.....	83
3.5.1.Individual configuration of channels.....	83
3.5.2.Configuring selected channels.....	83
3.5.3.Configuring all channels.....	83
3.6. UPDATING SOFTWARE OF PMS-90R DEVICE.....	84

Explanation of symbols used in the manual:



- This symbol denotes especially important guidelines concerning the installation and operation of the device. Not complying with the guidelines denoted by this symbol may cause an accident, damage or equipment destruction.

IF THE DEVICE IS NOT USED ACCORDING TO THE MANUAL THE USER IS RESPONSIBLE FOR POSSIBLE DAMAGES.



- This symbol denotes especially important characteristics of the unit. Read any information regarding this symbol carefully

I. USER MANUAL FOR “PMS-90R” DATA LOGGER

1. BASIC REQUIREMENTS AND USER SAFETY



- **The manufacturer is not responsible for any damages caused by inappropriate installation, not maintaining the proper technical condition and using the unit against its destination.**
- Installation should be conducted by qualified personnel . During installation all available safety requirements should be considered. The fitter is responsible for executing the installation according to this manual, local safety and EMC regulations.
- The unit must be properly set-up, according to the application. Incorrect configuration can cause defective operation, which can lead to unit damage or an accident.
- **If in the case of a defect of unit operation there is a risk of a serious threat to the safety of people or property additional, independent systems and solutions to prevent such a threat must be used.**
- **The unit uses dangerous voltage that can cause a lethal accident. The unit must be switched off and disconnected from the power supply prior to starting installation of troubleshooting (in the case of malfunction).**
- Neighbouring and mating equipment must meet the requirements of appropriate standards and regulations concerning safety and be equipped with adequate anti-overvoltage and anti-interference filters.
- **Do not attempt to disassemble, repair or modify the unit yourself. The unit has no user serviceable parts. Units, in which a defect was stated must be disconnected and submitted for repairs at an authorized service centre.**



- In order to minimize fire or electric shock hazard, the unit must be protected against atmospheric precipitation and excessive humidity.
- Do not use the unit in areas threatened with excessive shocks, vibrations, dust, humidity, corrosive gasses and oils.
- Do not use the unit in explosion hazard areas.
- Do not use the unit in areas with significant temperature variations, exposed to condensation or icing.
- Do not use the unit in areas exposed to direct sunlight.
- Make sure that the ambient temperature (e.g. inside the control box) does not exceed the recommended values. In such cases forced cooling of the unit must be considered (e.g. by using a ventilator).



The unit is designed for operation in an industrial environment and must not be used in a household environment or similar.

2. GENERAL CHARACTERISTICS

- **Multifunctional**

PMS-90R designed for recording, displaying current or averaged values and presentation of technological parameter trends in graphic form. All measured parameters must be available in 0-20 mA or 4-20 mA (this can be for example pressures, levels, humidity, temperatures, forces, etc.).

- **Large data storage capacity**

The registered measurement results are recorded in the unit's memory. The capacity of installed memory allows to store:

- over 500 000 measurements (2MB) for units equipped with RS485 interface
- over 2 000 000 measurements (8MB) for units equipped with RS485 interface and USB Host port.

- **Configurable measurement and control input**

The unit has up to 8 channels of 0-20 mA (4-20 mA) current signals and one digital voltage input with programmable functions, e.g. control of the recording process. Each signal can be freely configured and described. The internal analogue-digital converter has a 12 bit resolution, which provides high recording resolution results. Additionally, individual alphanumeric description (text) of each of the recorded channels is possible.

- **Fast serial interface**

The data recorder is fitted with a galvanic insulated RS 485 interface, programmed with ModBus RTU transmission protocol. This enables the connection of a number of data recorders into the network, remote collecting of data from each unit and also remote configuration. The application of the RS 485 interface instead of RS 232 is due to the possibility of achieving high transmission speeds using transmission lines of larger length than is possible with the RS 232 interface.

- **Built-in USB Host interface (optional)**

Optionally the data logger can be equipped with built-in USB Host interface, allowing for data transfer to popular USB Flash Drives (PenDrives). This method allows for significant simplification of unit application: it is no longer necessary to connect PC and **PMS-90R** via RS-485 interface.

Significant acceleration of data transfer is an additional advantage: data download can be 10 times faster than using RS-485 interface.

WARNING! PMS-90R should work properly with any standard Flash Drives, but manufacturer can not guarantee proper cooperation with non-standard devices, or with devices developed after **PMS-90R** release.

- **Wide range of power supply voltage and external sensor power supply**
The built-in pulse power supply allows power to be supplied to the unit with 85...**230**...260V AC/DC voltage or 16...**24**...35 AC, 19...**24**...50 DC voltage (depending on version). The voltage for powering the sensor and converters is connected to the rear terminal strip: 24V DC $\pm 5\%$ / max. 200mA.
- **Legible graphic display**
The 128 x 64 points display with a backlight mounted on front of the unit is a big advantage of the data recorder. It allows the display of trend graphs for each channel separately. Different operation modes provide the possibility of selecting and adjusting the method of data presentation depending on the user's requirements. Data recording intervals are selected by the user from the menu level. Additionally, it is possible to set the display to show one current value measured for a selected channel.
- **Easy configuration**
There are 6 keys on the front of the data recorder that enable the configuration of the unit. The menu assisted with full text descriptions makes the unit configuration process quite easy. However, due to a significant number of configured parameters it is advised to use the attached configuration software for PCs.

3. TECHNICAL DATA

Power supply voltage (depending on version)	85... 230 ...260V AC/DC; 50 \div 60 Hz
External Fuse (required)	or 19... 24 ...50V DC; 16V... 24 ...35V AC
Power consumption	T - type, max. 2 A typically 7 VA; max. 12 VA
Inputs	
Measurement:	up to 8 inputs 0-20 mA or 4-20 mA, common ground
Digital:	1 input 24V DC, galvanic insulation power consumption: 7,5 mA / 24V, insulation: 1min @ 500V DC.
Sensor power supply output	24V DC $\pm 5\%$ / max. 200 mA, Not insulated from measurement inputs
Measurement range	± 9999 plus decimal point
Current measurement accuracy	$\pm 0,25\% \pm$ one digit (for 0-20 mA range)
Accepted prolonged input overload:	20%
Measurement input resistance	100 Ω
Communication interface	RS 485, 8N1 / Modbus RTU, not separated
Baud rate	1200 bit/s \div 115200 bit/s
USB Host interface (optional)	Cooperation with standard Flash Disks (USB 2.0)

Display	LCD graphic display, 128 x 64 points, with backlight
Data memory	2MB - version without USB Host 8MB - version with USB Host interface
Protection level	
version without USB interface	IP 65 (from front, after using waterproof cover) IP 40 (from front) IP 20 (housing and connection clips)
version with USB interface	IP 42 (from front, after using waterproof cover) IP 20 (housing and connection clips)
Housing type	panel
Housing material	NORYL - GFN2S E1
Housing dimensions	96 x 96 x 100 mm
Mounting hole	90,5 x 90,5 mm
Assembly depth	102 mm
Panel thickness	max. 5 mm
Operating temperature	0°C to +50°C
Storage temperature	-10°C to +70°C
Humidity	5 to 90% no condensation
Altitude	up to 2000 meters above sea level
Screws tightening max. torque	0,5 Nm
Max. connection leads diameter	2,5 mm ²
Safety requirements	according to: PN-EN 61010-1 installation category: II pollution degree: 2 voltage in relation to ground: 300V AC insulation resistance: >20MΩ insulation strength between power supply and input/output terminal: 1min. @ 2300V (see Fig. 3.1)
EMC	PN-EN 61326

Software (Windows environment)

- **S-Toolkit**, PC software for data logger easy configuring,
- **Loggy Soft**, PC software for moving, reporting, archiving and displaying recorded data.



This is a class A unit. In housing or a similar area it can cause radio frequency interference. In such cases the user can be requested to use appropriate preventive measures.



Carefully check that the insulation used with the unit (Fig. 3.1) meets the expectations and if necessary use appropriate measures of overvoltage protection. Additionally, assure the maintenance of appropriate installation air and surface insulation gaps (Tab. 3.1).

Range of operating voltage	Air gap [mm]	Surface gap [mm]
Up to 50V RMS or DC	0,2	1,2
Up to 100V RMS or DC	0,2	1,4
Up to 150V RMS or DC	0,5	1,6
Up to 300V RMS or DC	1,5	3,0

Tab. 3.1. Minimal insulation gaps according to EN 61010-1

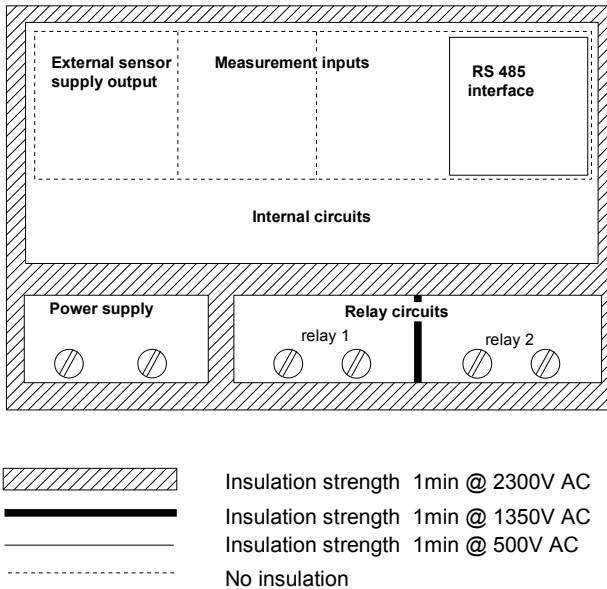

Fig. 3.1. Schematic diagram showing the insulation between individual circuits of the unit.

4. DEVICE INSTALLATION

The unit has been designed and manufactured in a way assuring a high level of user safety and resistance to interference occurring in a typical industrial environment. In order to take full advantage of these characteristics installation of the unit must be conducted correctly and according to the local regulations.



- Read the basic safety requirements on page 4 prior to starting the installation.
- Ensure that the power supply network voltage corresponds to the nominal voltage stated on the unit's identification label.
- The load must correspond to the requirements listed in the technical data.
- All installation works must be conducted with a disconnected power supply.
- Protecting the power supply clamps against unauthorized persons must be taken into consideration.

4.1. UNPACKING

After removing the unit from the protective packaging, check for transportation damage. Any transportation damage must be immediately reported to the carrier. Also, write down the unit serial number on the housing and report the damage to the manufacturer.

Attached with the unit please find:

- assembly brackets - 2 pieces,
- warranty,
- user's manual for **PMS-90R** unit (device)
- user's manuals for cooperating software,
- CD-ROM with the aforesaid manual in PDF format and installation files of cooperating software.

4.2. ASSEMBLY



- The unit is designed for mounting indoor inside housings (control panel, switchboard) assuring appropriate protection against electric impulse waves. Metal housing must be connected to the grounding in a way complying with the governing regulations.
- Disconnect the power supply prior to starting assembly.
- Check the correctness of the performed connections prior to switching the unit on.

In order to assembly the unit, a 90,5 x 90,5 mm mounting hole (Fig. 4.1) must be prepared. The thickness of the material of which the panel is made must not exceed 5mm. When preparing the mounting hole take the grooves for catches located on both sides of the housing into consideration (Fig. 4.1). Place the unit in the mounting hole inserting it from the front side of the panel, and then fix it using the brackets (Fig. 4.2). The minimum distances between assembly holes' axes - due to the thermal and mechanical conditions of operation - are 115 mm x 115 mm (Fig. 4.4).

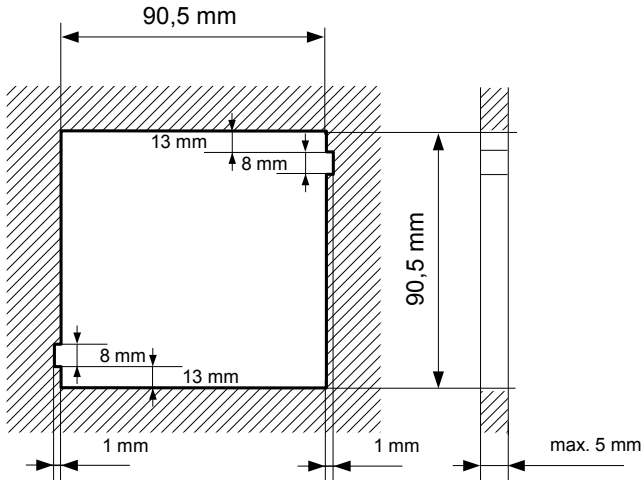

Fig. 4.1. Mounting hole dimensions

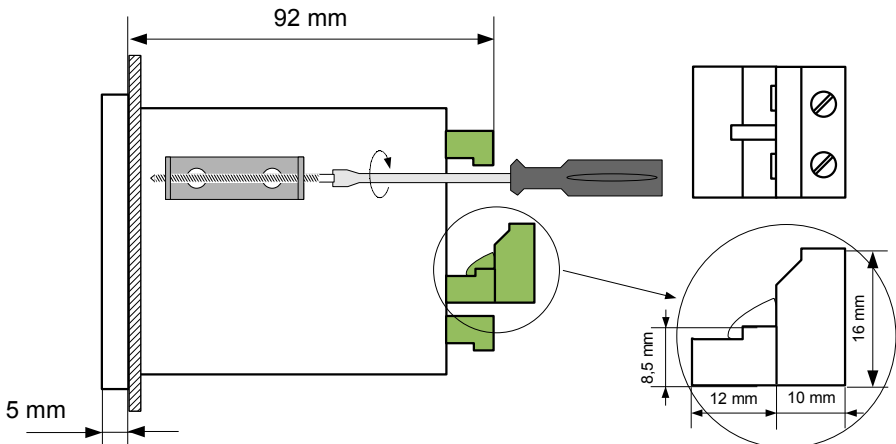

Fig. 4.2. Installing of brackets, and dimensions of connectors.

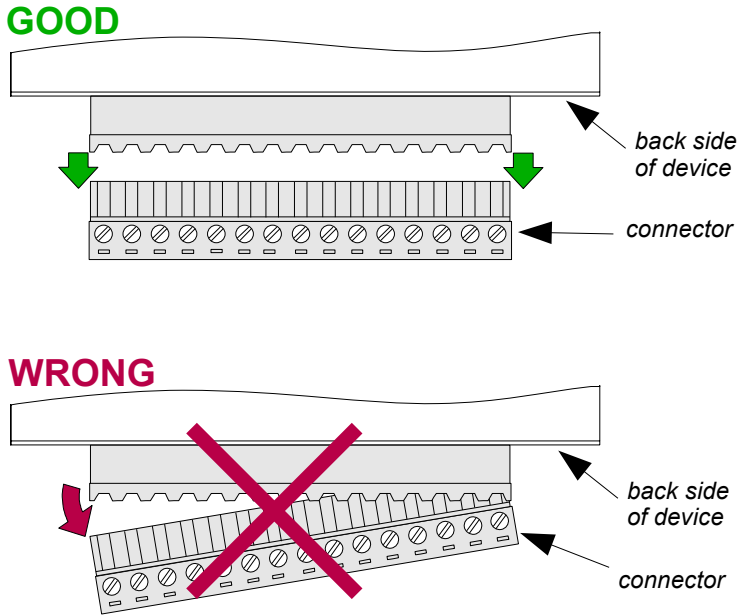

Fig. 4.3. Connectors removing method

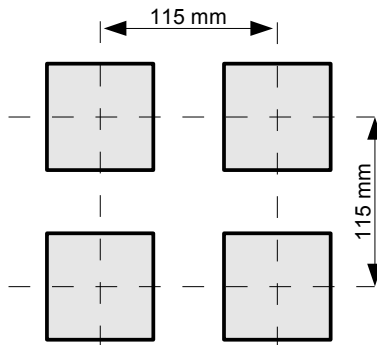

Fig. 4.4. Minimum distances when assembly of a number of units

4.3. CONNECTION METHOD

Caution



- Installation should be conducted by qualified personnel . During installation all available safety requirements should be considered. The fitter is responsible for executing the installation according to this manual, local safety and EMC regulations.
- The unit is not equipped with an internal fuse or power supply circuit breaker. Because of this an external time-delay cut-out fuse with minimal possible nominal current value must be used (recommended bipolar, max. 2A) and a power supply circuit-breaker located near the unit. In the case of using a monopolar fuse it must be mounted on the phase cable (L).
- The power supply network cable diameter must be selected in such a way that in the case of a short circuit of the cable from the side of the unit the cable shall be protected against destruction with an electrical installation fuse.
- Wiring must meet appropriate standards and local regulations and laws.
- In order to secure against accidental short circuit the connection cables must be terminated with appropriate insulated cable tips.
- Tighten the clamping screws. The recommended tightening torque is 0.5 Nm. Loose screws can cause fire or defective operation. Over tightening can lead to damaging the connections inside the units and breaking the thread.
- In the case of the unit being fitted with separable clamps they should be inserted into appropriate connectors in the unit, even if they are not used for any connections.
- **Unused clamps (marked as n.c.) must not be used for connecting any connecting cables (e.g. as bridges), because this can cause damage to the equipment or electric shock.**
- If the unit is equipped with housing, covers and sealing packing, protecting against water intrusion, pay special attention to their correct tightening or clamping. In the case of any doubt consider using additional preventive measures (covers, roofing, seals, etc.). Carelessly executed assembly can increase the risk of electric shock.
- After the installation is completed do not touch the unit's connections when it is switched on, because it carries the risk of electrical shock.

Due to possible significant interference in industrial installations appropriate measures assuring correct operation of the unit must be applied. To avoid the unit of improper indications keep recommendations listed below.

- Avoid common (parallel) leading of signal cables and transmission cables together with power supply cables and cables controlling induction loads (e.g. contactors). Such cables should cross at a right angle.
- Contactor coils and induction loads should be equipped with anti-interference protection systems, e.g. RC-type.

- Use of screened signal cables is recommended. Signal cable screens should be connected to the earthing only at one of the ends of the screened cable.
- In the case of magnetically induced interference the use of twisted couples of signal cables (so-called “spirals”) is recommended. The spiral (best if shielded) must be used with RS-485 serial transmission connections.
- In the case of interference from the power supply side the use of appropriate anti-interference filters is recommended. Bear in mind that the connection between the filter and the unit should be as short as possible and the metal housing of the filter must be connected to the earthing with largest possible surface. The cables connected to the filter output must not run in parallel with cables with interference (e.g. circuits controlling relays or contactors).

Connections of power supply voltage and measurement signals are executed using the screw connections on the back of the unit’s housing.

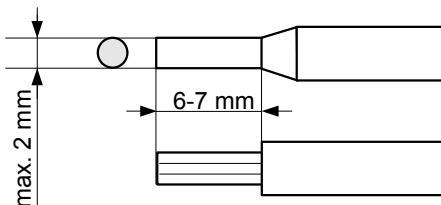

Fig. 4.5. Method of cable insulation replacing and cable terminals dimensions



All connections must be made while power supply is disconnected !

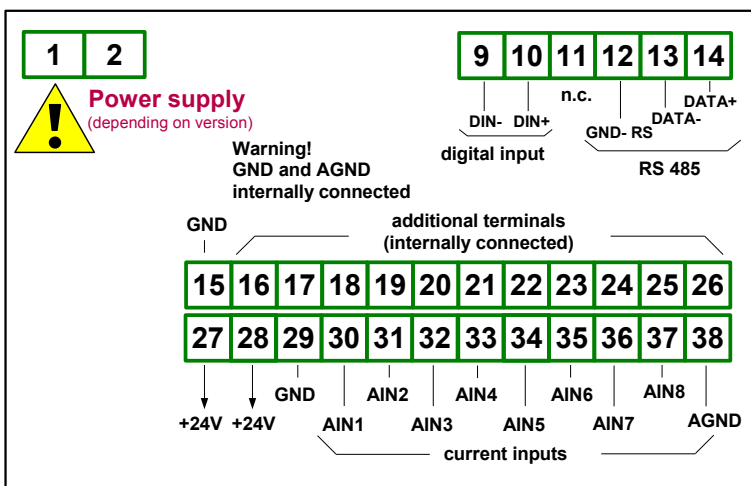

Fig. 4.6. Terminals description

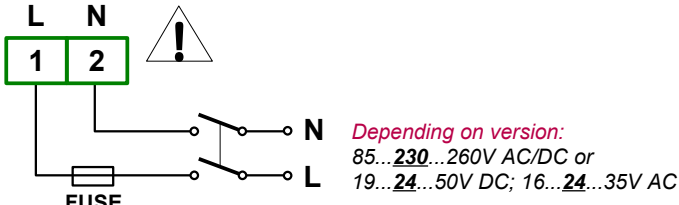

Fig. 4.7. Connection of power supply

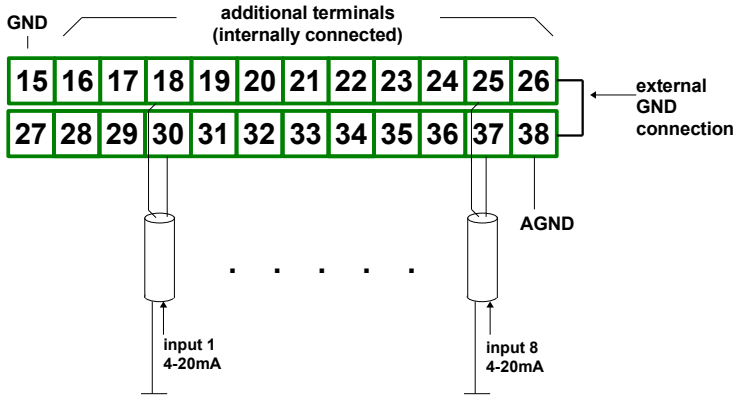

Fig. 4.8. Connections of current signals of active sensors (current signal 0-20 mA or 4-20 mA and ground)

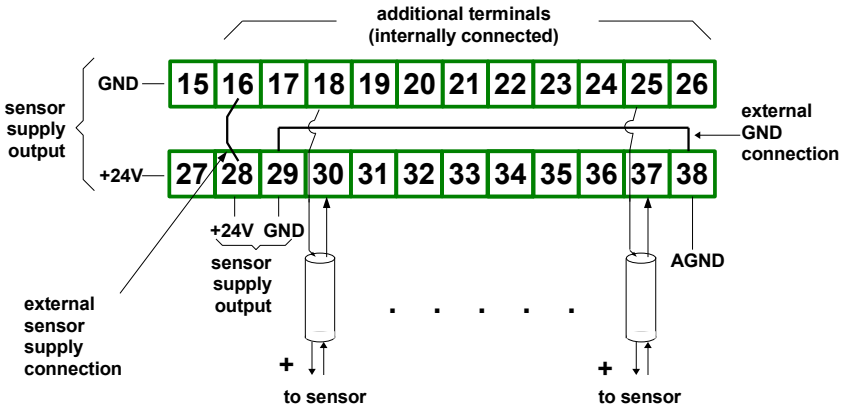

Fig. 4.9. Connections of current signals of 2-wire sensors (sensor power supply voltage and 4-20 mA signal)

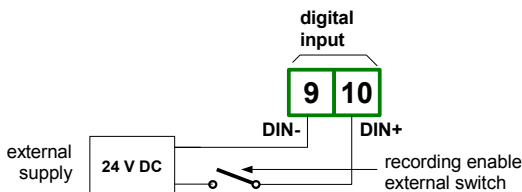

Fig. 4.10. Connection of digital input (depending on data recorder configuration)

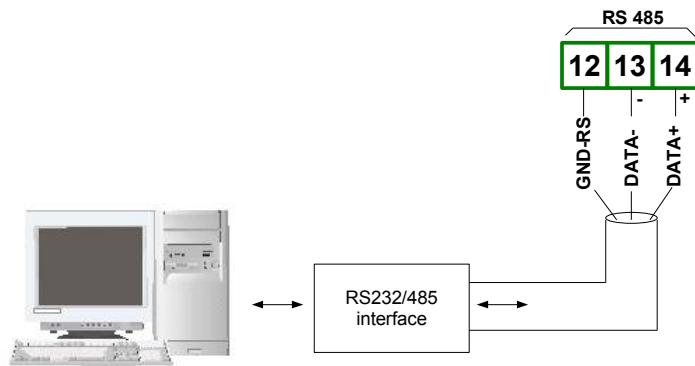

Fig. 4.11. Connection of RS-485 transmission signals

The **PMS-90R** device supports the following converters:

- USB / RS-485 converter (**Converter USB/RS485**)
- RS-232 / RS-485 converter (**Converter 232/RS485**)

4.4. MAINTENANCE

The unit does not have any internal replaceable or adjustable components available to the user. Pay attention to the ambient temperature in the room where the unit is operating. Excessively high temperatures cause faster ageing of the internal components and shorten the fault-free time of unit operation.

In cases where the unit gets dirty do not clean with solvents. For cleaning use warm water with small amount of detergent or in the case of more significant contamination ethyl or isopropyl alcohol.



Using any other agents can cause permanent damage to the housing.



Product marked with this symbol should not be placed in municipal waste. Please check local regulations for disposal and electronic products.

5. FRONT PANEL DESCRIPTION

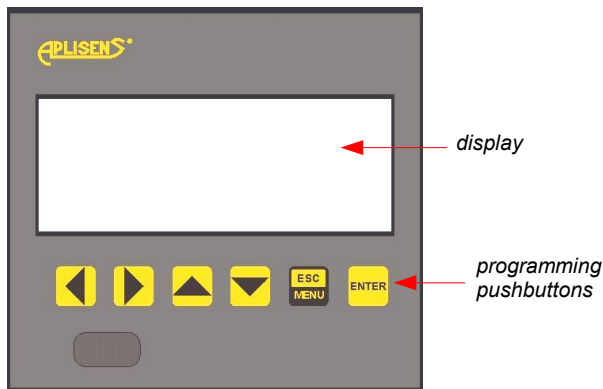

Key designation and functions



Symbols used in the manual: **[ESC/MENU]** and 

Functions:

- go to main menu (press and hold by at least 2 sec.),
- go to result presentation modes menu,
- exit the current level and return to previous menu (or to one of result presentation modes),
- cancellation of changing the edited data logger parameter.



Symbols used in the manual: **[ENTER]** and 

Functions:

- start editing parameter,
- go to submenu,
- confirm change of edited parameter.



Symbols used in the manual: **[<] [>]** and 

Functions:

- change the horizontal cursor position,
- modify edited data logger parameter
- change of channel number in one of four result presentation modes and during measurement channel configuration.



Symbols used in the manual: **[^] [v]** and 

Functions:

- change the vertical cursor position,
- modify edited data logger parameter,
- change of channel result presentation mode.

6. PRINCIPLE OF OPERATION

After turning the power supply on, the logo and basic unit data are showed on the display, then the unit goes to the measurement mode.

6.1. MEASUREMENT MODE

In the measurement mode the unit executes the measurement of values of signals connected to current inputs, hereafter called measurement channels (the number of available channels depends on the unit version). Measurements are conducted at the frequency of 8 times per second for each channel. The nominal range of input current for each input is 0-20 mA or 4-20 mA and can be extended to the maximum of 0-22 mA, independently to each measurement channel. The results of the conducted measurements are shown on the LCD display. The unit computes the measurement results into indicated values proportionally (linear). The range of measurement results corresponding to the nominal range of input current is defined as **nominal measurement range**. The range of measurement results corresponding to the range of input current including the extensions is defined as **allowable measurement range** (Fig. 6.1).

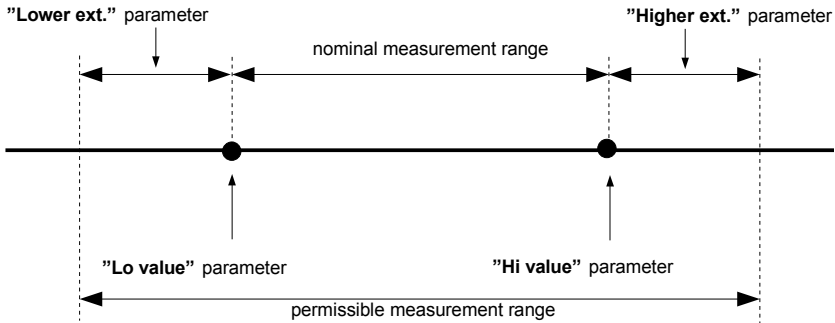

* "Lower ext." parameter is only significant for an input current range of 4-20 mA.

Fig. 6.1. Definition of measurement ranges

The range of displayed values, unit of measured value and position of the decimal point (for presentation in numeric form) are defined by the user.

All available parameters of the unit's operation can be configured in the main menu (see **DEVICE PROGRAMMING**) or using the RS 485 interface and software installed on your PC.



Configuration of the device (via menu or RS 485 interface) **do not stops the data recording process.**

Results of measurements conducted for active (selected by the user) channels of the unit are displayed in one of the available result presentation modes (see **RESULT PRESENTATION MODES**).

6.1.1. Recording momentary and averaged data

Values corresponding to the results of current measurement conducted for each channel can be recorded (stored in the non-volatile memory of the unit) for further analysis. The recording of measurement results for all channels is performed with the same frequency, defined by the user in the range between 1 record per second to 1 record per hour ("**Rec. period**" parameter). Recording times are synchronized with the internal real time clock. Recording can be stopped at any moment with selected status on digital input of the unit ("**Triggering**" parameter).

In order to enable more advanced mathematical processing of recorded signals it is possible to set the unit's options to record averaged measurement results. Setting the recorded value type to **averaged value** (parameters "**Channel 1**"... "**Channel 8**", depending on the number of channels in the unit) causes that instead of momentary values the unit records in its memory values that constitute the average results of measurements conducted during the set **recording period**. All measurements conducted by the unit shall be averaged (eight measurements per second), irrespective of the set recording frequency.

The principle of recording measurements is presented in figure 6.2. In the case of recording momentary values **t(a)**, **t(b)**, **t(c)** designate the recording times of values corresponding to current measurements **a_n**, **b_n**, **c_n**. In the case of recording averaged values **t(a)**, **t(b)**, **t(c)** designate the times of recording values corresponding to measurement averaging results, **a₁...a_n**, **b₁...b_n**, **c₁...c_n** correspondingly.

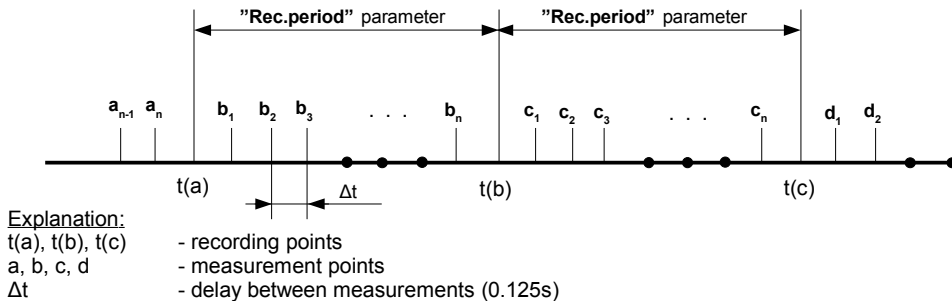

Fig. 6.2. Principle of measurement recording

i Averaging operation concerns **only** the type of recorded values; it does not concern the method of presentation of current measurement. In all result presentation modes, indications - described in the remaining part of the manual as results of measurements not recorded in the unit's memory - correspond to the momentary value of the measured signal.

Averaged values can be viewed in the data logger only in the "**Measurements list**" and "**Graph**" results presentation mode, because these modes enable presentation of values recorded in the unit's memory. Averaged values can also be viewed in the database downloaded by the software working with the data logger.

i In the case of multiple changes of type of recorded value (momentary values of averaged values) there is no possibility to distinguish whether data recorded in the memory concerns momentary measurement value or averaged measurement results.

Recording the measurement results in the non-volatile memory can be executed in two modes: "**until full**" or "**cyclic**" ("**Write**" parameter). The first mode enables the recording of such amounts of data as the unit's memory allows for, then the recording is stopped. In the second mode, once the memory is full, the results are recorded from the starting address in the memory, overwriting existing measurement results. The time remaining until the memory is full is displayed once the unit is started and in the "**Device information**" menu, available in the units main menu.

In the case of both modes, once the memory is full, a warning message is displayed (see description of "**Write**" parameter in the "**Logging setup**" menu). The recorded data should be periodically downloaded to a PC using appropriate software or alternatively using USB FlashDrive (method recommended for data loggers equipped with 8MB of memory).

All parameters concerning the recording mode, the influence of digital input on the recording method, the recording frequency and type of recorded value are available in the "**Logging setup**" menu described in section **MAIN MENU DESCRIPTION**.

6.2. MODES OF RESULT PRESENTATION

The results of measurements conducted for active channels are presented in numeric or graphic (graph or bar) form. Selection of one of the available results presentation modes can be made using the [**^**] and [**v**] keys in the measurement mode. Configuration of the method of displaying in the selected results presentation mode can be made in the menu of the given presentation mode (see **DESCRIPTION OF RESULTS PRESENTATION MODES MENU**). The following presentation modes are available:

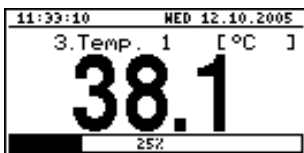

- "**Single channel**" mode (Fig. 6.3) enables the last measurement for one of the measurement channels to be viewed in the numeric and graphic form (bar).

Fig. 6.3. "**Single channel**" mode

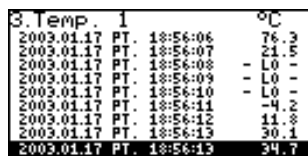

- "**Measurements list**" mode (Fig. 6.4) enables the momentary values recorded during the set period of time or averaged values of the conducted measurements for one of the measurement channels to be viewed in numeric form.

Fig. 6.4. "**Measurements list**" mode

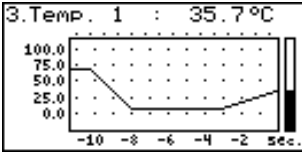

Fig. 6.5. "graph" mode

- "**Graph**" mode (Fig. 6.5) enables the momentary values or averaged values of measurements conducted for one of measurement channels to be viewed in the form of a graph.

11:48:32	WED 12.10.2005
1. Current	5.00 mA
2. Humidity	5.00 %RH
3. Temp. 1	31.3 °C
4. Temp. 2	625 °C
5. Pressure	- L0 -
6. Flow	- H1 -
7. Weight	0.0 kg
8. Position	0.00 H

Fig. 6.6. "**Channels list**" mode (values)

- "**Channels list**" mode (Fig. 6.6, 6.7) enables the measurement results for all active measurement channels to be viewed in numeric or graphic (bar) form.

11:48:32	WED 12.10.2005
1. Current	25%
2. Humidity	25%
3. Temp. 1	31%
4. Temp. 2	31%
5. Pressure	-22%
6. Flow	121%
7. Weight	0%
8. Position	0%

Fig. 6.7. "**Channels list**" mode (bars)



After starting the unit the result presentation mode and channel selected prior to switching off the unit are active (this information is stored in the EEPROM memory)

6.2.1. "Single channel" mode

This mode (Fig. 6.8) displays the result of the last measurement for one of the active channels in numeric form (in the middle part of the display) and in the form of a bar (percentage, at the bottom of the screen). The graphical indicator (bar) always shows the relation of the measurement result to the **nominal measurement range** (see description of "**Hi value**", "**Lo value**" parameters in the "**Inputs settings**" menu).

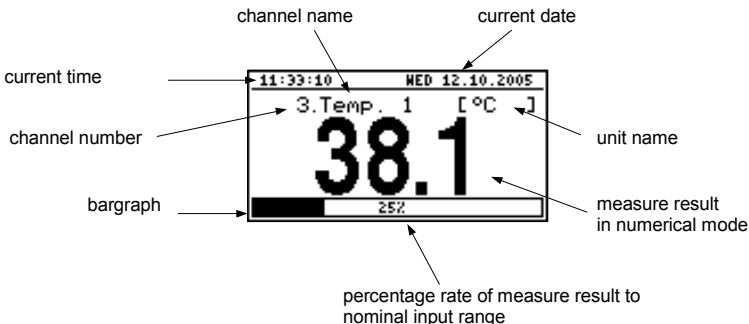

Fig. 6.8. Unit in "**Single channel**" result presentation mode

Exceeding the nominal measurement range (Fig. 6.9) is signalled on the bar with an arrow indicating the direction of exceeding the range. If the measurement result for one channel exceeds the allowable measurement range (Fig. 6.10) instead of the result in numeric form the display shows a "-Hi-" or "-Lo-" message (depending on the direction of exceeding, see

description of "Upper ext." and "Lower ext." parameters in "Inputs settings" menu).

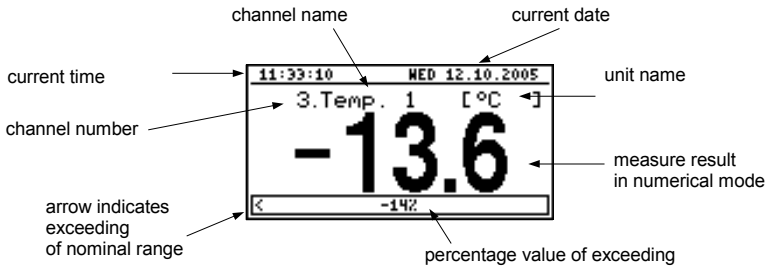

Fig. 6.9. Exceeding nominal range in "Single channel" mode

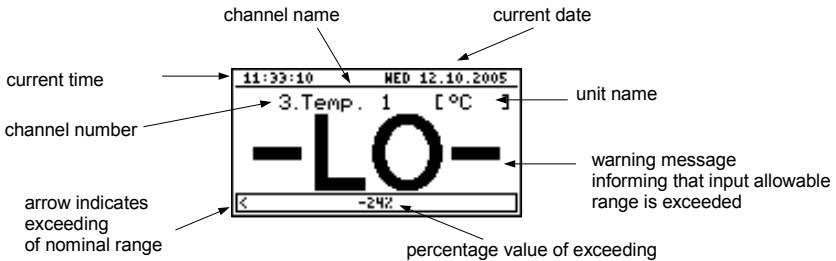

Fig. 6.10. Exceeding allowable range in "Single channel" mode

Functions of keys in "Single channel" mode:



- go to main menu (press and hold for approx. 2 seconds),



- change channel number,



- change results presentation mode.

6.2.2. "Measurements list" mode

The values displayed in this mode depend on the set type of recorded value (see description of parameters "Channel 1"..."Channel 8" in the "Logging setup" menu). In the case of recording momentary values in this mode (Fig. 6.11, 6.12) the display shows 9 consecutive measurement results (including their execution time) in numeric form for one of the active channels. It is possible to view the last recorded measurement results or results of measurements recorded previously (depending on the "List type" parameter setting in the "Measurements list options" menu). If the result of the measurement recorded for the given

channel exceeds **allowable measurement range**, instead of the result in numeric form the **"-Hi-"** or **"-Lo-"** message is displayed (depending on the direction of exceeding, see description of **"Upper ext."** and **"Lower ext."** parameters in the **"Inputs settings"** menu). In order to go to the **"Measurements list options"** menu press the **[ESC/MENU]** key.

If the **"List type"** parameter in the **"Measurements list options"** menu is set as **"current"** (Fig. 6.11), the last of the displayed results (displayed in negative) concerns the current measurement (not recorded). Above the result of the current measurement the display shows the measurement recorded so far (stored in the non-volatile memory) for the given channel. If there are no recorded measurements in the unit's memory at the moment, the list of recorded measurements will be empty and only the result of the current measurement will be displayed. Pressing the **[ENTER]** and **[^]** keys simultaneously allows list type to be switched from current to historical.

 Returning to the current list type is only possible from the **"Measurements list options"** menu.

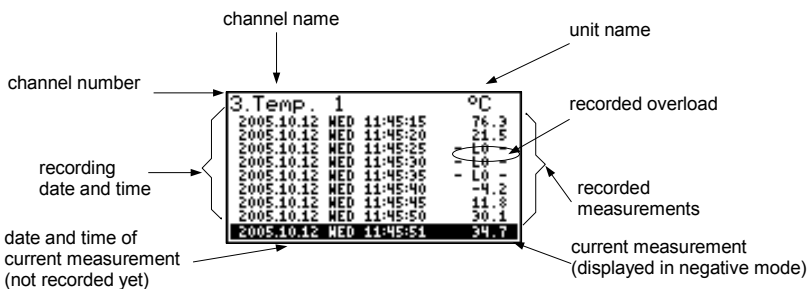

Fig. 6.11. Unit in **"Measurements list"** measurement results presentation mode. **"List type"** parameter set as **"current"**.

If the **"List type"** parameter in the **"Measurements list options"** menu was set as **"historical"** (Fig. 6.12), the last of the displayed results (displayed under the line) concerns the measurement recorded at the time (or directly after it) defined by **"Date"** and **"Time"** parameters in the **"Measurements list options"** menu. Above the line, the display shows results of previously recorded measurements, i.e. before the time defined by **"Date"** and **"Time"** parameters in the **"Measurements list options"** menu.

If there are no recorded measurements in the unit's memory, the list of recorded measurements will be empty. Holding down the **[ENTER]** key and **[^]** or **[v]** key at the same time allows the measurement list to be scrolled through.



During the download of data to be displayed from the unit's memory (recorded measurement results), an appropriate message is displayed instead of the measurement result (Fig. 6.13). "X" is displayed for data that has not been downloaded yet.

Functions of keys in "Measurements list" mode:



- go to main menu (press and hold for approx. 2 seconds),
- go to "**Measurements list options**" menu, description on page 32.



- change channel number,



- change results presentation mode.



- scroll through measurement list (for historical list),
- switching list type from current to historic (for current list).

6.2.3. "Graph" mode

Values displayed in this mode depend on the set type of recorded value (see description of parameters "**Channel 1**"..."**Channel 8**" in the "**Logging setup**" menu).

In the case of recording momentary values in this mode (Fig. 6.14) the display shows measurement results in the form of a graph, numeric form and in the form of a vertical bar. Numeric values (displayed over the graph) and vertical bar (displayed to the right of the graph) indicate the value corresponding to the result of the current measurement, irrespective of the set time scale of the graph. The graphical indicator (bar displayed to the right of the graph) always indicates the measurement result to the allowable measurement range ratio (see description of "**Hi value**" "**Lo value**" parameters in the "**Inputs settings**" menu).

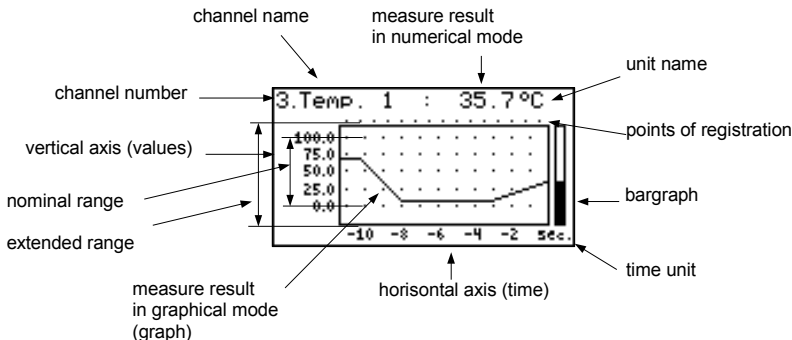

Fig. 6.14. Unit in "Graph" result presentation mode

Exceeding the **allowable measurement range** (Fig. 6.15, 6.16) is announced on the bar in

the form of an arrow indicating the direction of exceeding the range. If the measurement result for the given channel exceeds the **allowable measurement range** (Fig. 6.15, 6.16) instead of the current numeric value (displayed in the upper right corner) the display shows a "-Hi-" or "-Lo-" message (depending on the direction of exceeding, see description of "Upper ext." and "Lower ext." parameters in the "Inputs settings" menu).

warning message informing that input allowable range is exceeded

arrows inform that input allowable range is exceeded

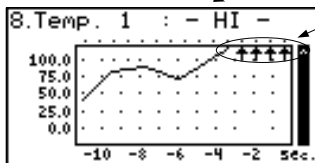

Fig. 6.15. Exceeding the upper limit of the allowable measurement range

The display shows points corresponding to measurement results. Directly after switching to the "Graph" mode the display shows points of the graph corresponding to measurement results recorded so far. The points that are displayed next correspond to the results of conducted measurements. Therefore, if there are recorded measurement results in the unit's memory, they shall be displayed directly after switching to the "Graph" mode, otherwise (no recorded measurements) the graph points corresponding to measurements results shall be plotted from the time this mode is switched on. If the measurement result for the given channel exceeds the **allowable measurement range**, then instead of the graph point corresponding to the measurement result, the display shows an arrow indicating the direction of exceeding the range (Fig. 6.15, 6.16). Above the upper limit of graph window the display shows points corresponding to the measurement recording times.

The vertical scale of the graph covers the values defined for the nominal range by "Hi value" and "Lo value" parameters including extensions ("Upper ext." and "Lower ext." parameters).

warning message informing that input allowable range is exceeded

arrows inform that input allowable range is exceeded

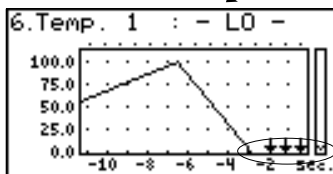

Fig. 6.16. Exceeding lower limit of the allowable measurement range

In the case of recording averaged values all points of the graph, concerning values recorded in the unit's memory, constitute averaged measurement results. Indicators (numeric, bar) and points of the graph, corresponding to current values refer to the momentary measurement value.

When recording averaged measurement results exceeding the **allowable measurement range** is understood as exceeding of this range by at least one of the measurements to be

averaged.

In the case of the upper limit, lower limit, or both limits of measurement range being exceeded in the given **recording period**, values represented in the form of arrows indicating the direction of exceeding (up, down, or both directions) will be recorded in the unit's memory instead of the averaged results.

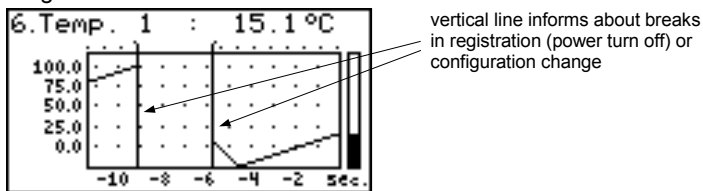

Fig. 6.17. Breaks in registration or change of configuration in "Graph" mode.

Changes of settings configuring the operation of a given channel and operation stoppage are signalled in the form of a vertical line (Fig. 6.17).

- i** If the settings of the horizontal scale (time scale) will be too big (time/point) in relation to speed of changes of the measurement signal, the graph can become illegible. If this is the case, change the time scale settings. The horizontal scale settings (time scale) can be changed in the "Graph options" menu. In order to go to the "Graph options" menu press the [ESC/MENU] key.

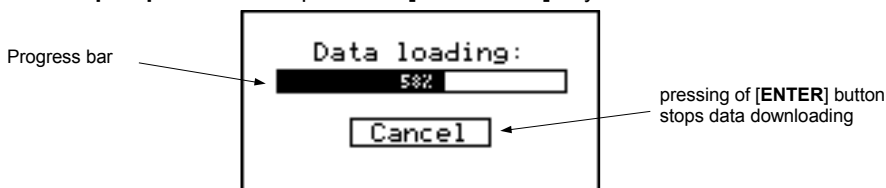

Fig. 6.18. Message displayed when loading data to be displayed on the graph.

- i** If downloading the data (recorded measurement results) necessary for displaying the graph takes more than 1 second an appropriate message is displayed (Fig. 6.18). Pressing [ENTER] will stop the data downloading process and display a graph made on the basis of the data downloaded so far. "X" will be displayed instead of data that was not downloaded (Fig. 6.19).

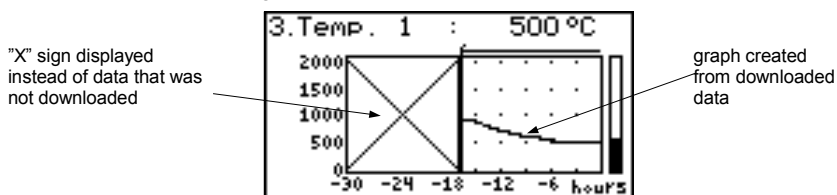

Fig. 6.19. Display in "Graph" mode in the case where data upload was stopped.

Functions of keys in "Graph" mode:



- go to main menu (press and hold for approx. 2 seconds),
- go to "**Graph options**" menu, description on page 33.



- change channel number,



- change results presentation mode.

6.2.4. "Channels List" mode

In this mode (Fig. 6.20, 6.21) the display shows the results of the current measurements for the active channels of the unit. The measurement results can be presented in numeric form or in the form of a bar (percentage) depending on the settings in the "**Channels list options**" menu. Graphic indicators (bars) always show the measurement result to the **nominal measurement range** ratio.

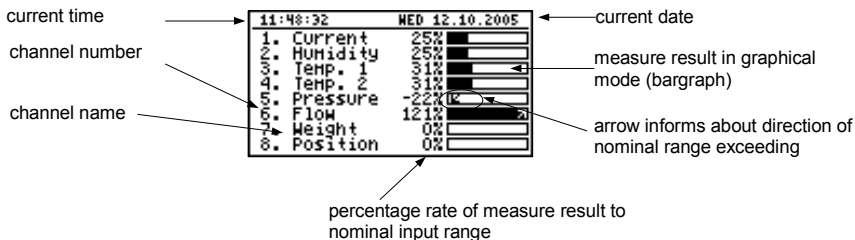

Fig. 6.20. Unit in "**Channels list**" results presentation mode. "**Channels list options**" parameter set as "**bar graphs**".

Exceeding the **nominal measurement range** is signalled on the bars in the form of an arrow indicating the direction of exceeding the range. If the measurement result for a given channel exceeds the **allowable measurement range**, instead of the current result in numeric form the display shows a "-Hi-" or "-Lo-" message (depending on the direction of exceeding, see description of "**Upper ext.**" and "**Lower ext.**" parameters in "**Inputs settings**" menu). Press the [ESC/MENU] key to go to "**Channels list options**" menu.

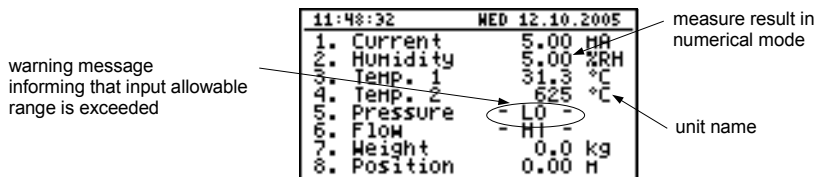

Fig. 6.21. Unit in "**Channels list**" results presentation mode. "**Channels list options**" parameter set as "**values**".

Functions of keys in "Channels list" mode:



- go to main menu (press and hold for approx. 2 seconds),
- Go to "**Channels list options**" menu, description on page 34.



- change channel number.



- change results presentation mode.

7. DEVICE PROGRAMMING

Defining the method of displaying measurement results in the selected results presentation mode can be done in the presentation mode menu. The meaning of individual parameters available for selected modes of results presentation is described in the **DESCRIPTION OF RESULTS PRESENTATION MENU MODES** section. In order to get to the configuration menu of selected results presentation mode, press the [ESC/MENU] key in the current results presentation mode.

The unit's main menu (Fig. 7.1) enables necessary information about the unit to be obtained and allows the setting of all parameters of the unit related to operation of measurement channels, communications using the RS 485 interface, LCD display, access settings, and other. The meaning of particular parameters of the unit is described in section **MAIN MENU DESCRIPTION**.

To access the main menu press down and hold for approx. 2 seconds the [ESC/MENU] key in any results presentation mode.

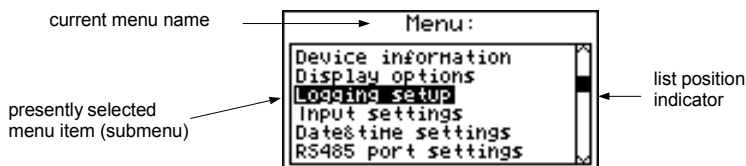

Fig. 7.1. Main menu of the unit

If the "**Password**" option in the "**Access setup**" menu was defined, then the user will have to provide the password (Fig. 7.2) before proceeding to menu options (the password is entered the same way as changing a numeric parameter, see **EDITING PARAMETERS**).

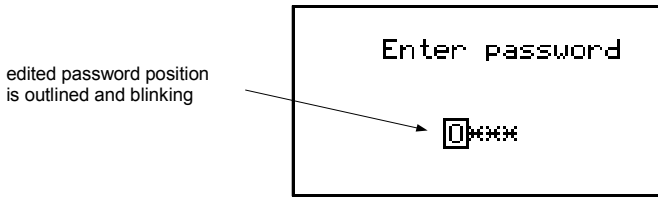

Fig. 7.2. Password requested when accessing unit's main menu.

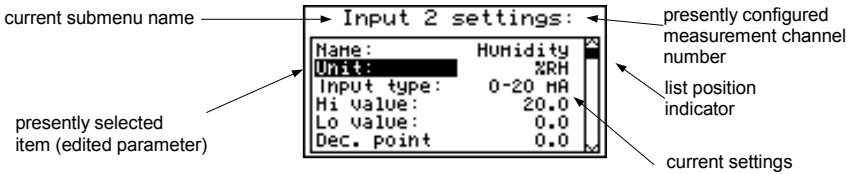

Fig. 7.3. Example of submenu

Functions of the buttons while sub-menu and parameters choice:



- Change the number of the configured channel (only in "Inputs settings" submenu).



- Change of current item in the menu (selecting a lower level menu or parameter for editing). The selected option is distinguished by displaying the option name in negative (bright lettering on dark background).



- The function of the **[ENTER]** key depends on the type of current menu item:
- if the menu item corresponds to one of the unit's parameters, pressing **[ENTER]** starts parameter editing,
 - if the menu item selects a lower level menu, pressing **[ENTER]** activates the new menu.



- The **[ESC/MENU]** key exits the current menu level and returns to a higher order menu (to one of the results presentation modes).



After approximately 1 minute since the last activation of the keys, the unit returns from any level to one of the results presentation modes (only if no parameters are in editing mode).

7.1. PARAMETERS EDITION

To start edition of any parameter user should select name of desired one using **[^] [v]** buttons and then **[ENTER]**.

7.1.1. Numeric and switching parameters ("LIST" - type)

Numeric parameters constitute a series of digits that form a number in decimal format.

Entering a new parameter value (Fig. 7.4) consists of changing the values of selected digits within the allowable range (using the [^], [v] keys). Some numeric parameters can take negative values (e.g. "Hi value" parameter). In such cases the "-" mark can be selected on the first decimal position of the parameter.

Switching parameters (Fig. 7.5) can be presented in the form of a list, out of which only one of the options available on the list can be selected for the given parameter. Options of switching parameter are selected using [^], [v] keys.

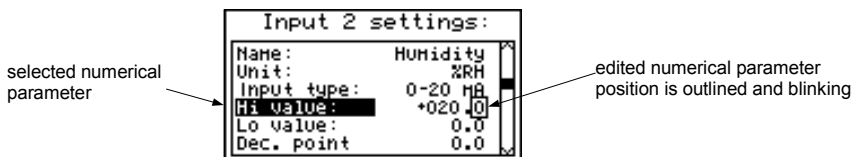

Fig. 7.4. Editing numerical parameter

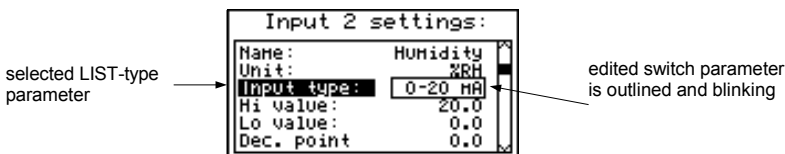

Fig. 7.5. Editing "LIST" - type switching parameter

Functions of keys when editing numeric and switching parameters:



- Selecting the decimal position of the edited numeric parameter. Selected item is distinguished with brackets and flashes. In the case of switching parameters these keys are not used.



- Change of current value (i.e. flashing) of the digit (for numeric parameters) or switching status (for switching parameters, e.g. "Input type").



- Confirm the changes and end parameter editing.



- Cancel changes.

7.1.2. Text parameters

Text parameters constitute a series of characters selected from the character table (Fig. 7.7) stored in the unit's memory. Entering the new parameter value (Fig. 7.6, 7.7) consists of selecting consecutive characters of the text by indicating the position of the character in the

table displayed below edited text. The edited character is placed in brackets and flashes; its source is indicated in the characters table with brackets surrounding the edited character.

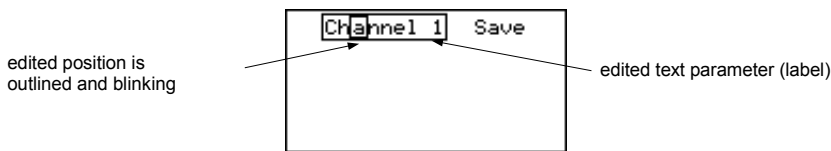





Fig. 7.6. Selection of character for editing

Functions of keys when selecting character for editing (characters table is not displayed at that time):

- 

 - Selecting the position of edited character or option of saving text parameter. The selected character (save option) is distinguished with brackets.
- 
 - Start editing the character for the selected position
 - Confirm the changes and finish parameter editing (when option "Save" is distinguished with brackets and flashes).
- 
 - Cancel changes (at any time).

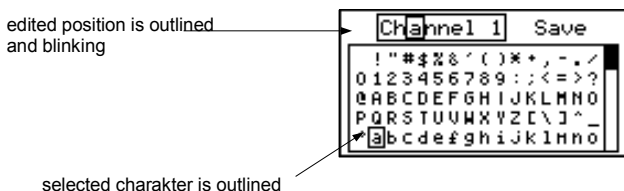







Fig. 7.7. Character editing

Functions of keys when editing selected character (at this time characters table is displayed below the edited parameter):

- 

 - Selecting the character from the given line of characters table for the edited position of the text parameter.
- 

 - Selecting the character from the given column of characters table for the edited position of the text parameter.
- 
 - Confirm the selected character from characters table for the edited position and start editing next character or completing character editing (if the edited character was the last one in the sequence).
- 
 - Cancel changes (at any time).

7.1.3. "SLIDER" - type parameters

The parameters of this type are presented graphically in the form of a bar that turns black correspondingly to the ratio of the current value of the selected parameter to the maximum value of this parameter. Entering the new parameter value (Fig. 7.8) consists of changing the level of "blackening" the bar within the allowable range using the [←], [→] keys.

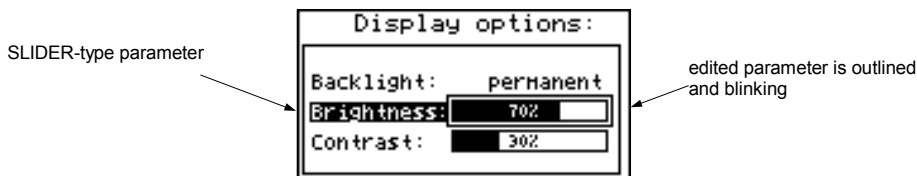

Fig. 7.8. Editing "SLIDER" - type parameter

Functions of keys when editing "SLIDER" - type parameters:



- Change the value of edited parameter. The edited parameter placed in brackets and flashes.



- Finish editing parameter.



- Cancel changes (at any time).

7.2. DESCRIPTION OF RESULTS PRESENTATION MODES MENU

Press the [ESC/MENU] key in the current results presentation mode to go to the results presentation mode configuration menu.

7.2.1. "Measurements list options" menu

This menu (Fig. 7.9) contains options configuring the method of displaying measurement results for the "Measurements list" mode:

"List type" - this option allows the establishing of which results of recorded measurements

are to be presented. The following options are available:

- "current" - the most recently recorded 8 (or less) measurement results and the results of the current measurement shall be displayed. The value shown in the lower part of the display (in negative) represents the result of the current (not recorded yet) measurement. The measurement results recorded so far (stored in the non-volatile memory) for the given channel are shown above the current measurement.

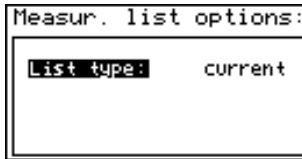

Fig. 7.9. "Measurements list options" menu.
"List type" parameter set as "current".

"historical" - the display will show 8 (or less) measurement results recorded before and 1 measurement result (located in the lower part of display, under the line) recorded at the time (or directly after it) defined by "Date" and "Time" parameters in the "Measurements list options" menu. The values shown above the line refer to measurements recorded before the time defined by "Date" and "Time" parameters.

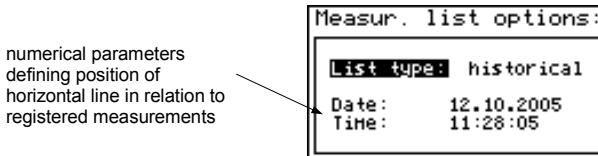

Fig. 7.10. "Measurements list options" menu.
"List type" parameter set as "historical".

"Date", "Time" - these options are available when the "List type" parameter was set as "historic" and define the position of the horizontal line (located in the lower part of the display) in relation to the recorded measurements results displayed on the list. Above the horizontal line the display shows the results of the measurement recorded before the time defined by "Date" and "Time" parameters. Below the horizontal line display shows the result of the measurement at the time (or directly after it) defined by "Date" and "Time" parameters. The default values "Date" and "Time" parameters are the time and date when the unit was switched on last.

7.2.2. "Graph options" menu

This menu contains options configuring the method of displaying measurement results for the "Graph" mode:

"Scale" - this option allows time points corresponding to particular points on the horizontal axis of the graph (time axis) to be defined. 16 options are available: from **0.125 seconds/point** to **1 hour/point**.

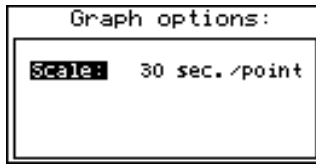

Fig. 7.11. "Graph options" menu

7.2.3. "Channels list options" menu

This menu contains options configuring the method of displaying measurement results for the "Channels list" mode:

"Display" - this option enables the selection of the method of displaying measurement results. The following possibilities are available:

- "values" - measurement results displayed in numeric form
- "bar graphs" - measurement results displayed in the form of bars (percentage)

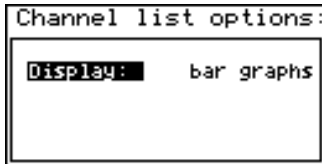
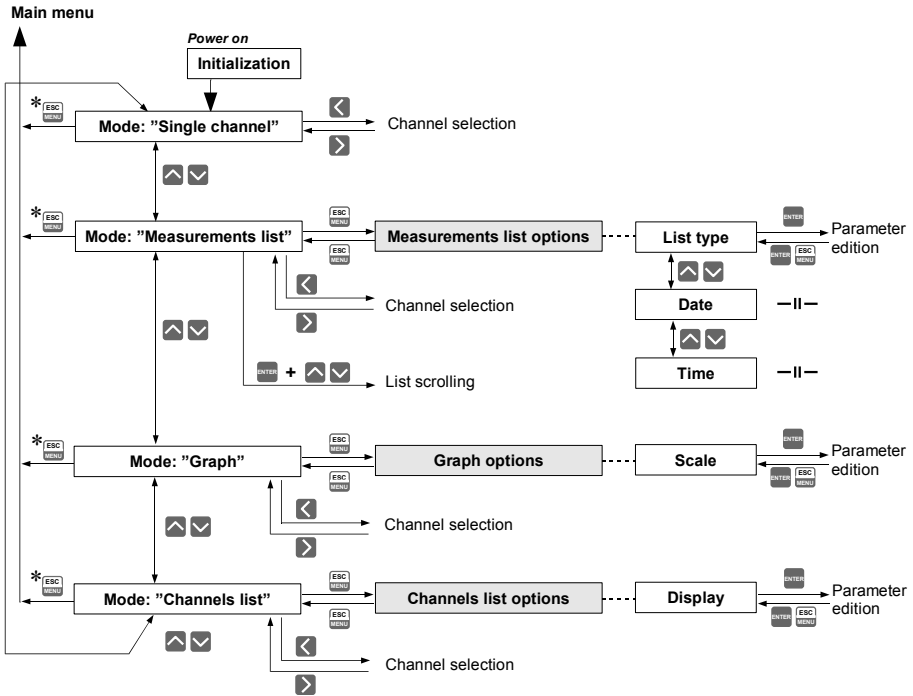

Fig. 7.12. "Channels list options" menu

7.3. RESULTS PRESENTATION MODES MENU STRUCTURE



* Press and hold at least 2 seconds

7.4. MAIN MENU DESCRIPTION

7.4.1. "Device information" menu

This menu contains information about the unit and cannot be edited:

- "Version" - version of unit firmware,
- "Serial no" - unit serial number,
- "Memory" - unit's memory size,
- "Used" - size of used memory,
- "Time left" - time remaining until memory will be filled with recorded values,

established on the basis of the currently set recording period and the number of recorded channels. In the case of controlling the recording process using the digital input, the value shown relates to the time, during which the voltage level on the digital input allows the recording of measurements. If no measurement channels are active the **"Logging disabled"** message is displayed.

Once the memory is filled with recorded measurement results, the **"Data overwriting"** or **"Logging stopped"** message is displayed (depending on the set value of the **"Write"** parameter in the **"Logging setup"** menu).



The calculated **"Time left"** time is an **approximated** value. Download the recorded data to your PC before this time expires. The data downloaded to a PC remain in the unit's memory, but is not taken into consideration when the **"Time left"** parameter is established and can be deleted without warning at any moment.

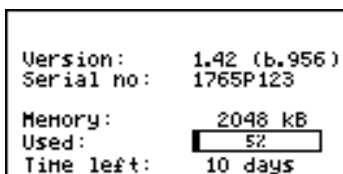

Fig. 7.13. "Device information" menu

7.4.2. "Display options" menu

This menu contains options that enable the displaying parameters of the LCD to be changed:

"Backlight" - this option allows one to define when the LCD backlight is to be switched on. The following possibilities are available:

"permanent" - backlight always On,

"temporary" - backlight is turned on when any key on the unit is pressed and switches Off after 1 minute since the last activation of the keys, and turned on for approximately 10 seconds when the unit is switched on.

"Brightness" - brightness of display backlight as a percentage

"Contrast" - contrast of the display as a percentage



If the display backlight is inactive and the **"Backlight"** option was set as **"temporary"** pressing any key will **only** switch the backlight on.

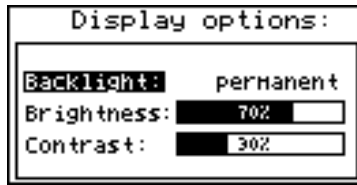

Fig. 7.14. "Display options" menu

7.4.3. "Logging setup" menu

This menu contains options defining the recording method and recorded channels:

"Write" - this option defines the behaviour of the unit after writing all available memory with the recorded measurement results. The following options are available:

"until full" - once the entire available memory is filled with recorded measurement results the recording will be stopped and a warning message (Fig. 7.15) shall be displayed; this warning message must be confirmed with the [ENTER] key. This warning shall be repeated when the unit is switched on. Instead of "Time left" parameter in the "Device information" menu the display will show the "Logging stopped" message. The recording will be restarted only when the collected measurement results are downloaded to a PC (once unit's memory is free). If the collected measurement results will be downloaded to a PC before memory is full, the warning message will not be displayed.



Fig. 7.15. Warning in "until full" recording mode

"cyclic" - after filling all the available memory with recorded measurement results, the measurement results recorded next will be written from the starting address in the memory, overwriting previously recorded data. During the first overwriting operation a warning message (Fig. 7.16) will be displayed; this message must be confirmed with the [ENTER] key. This warning shall be repeated when the unit is switched on. Instead of "Time left" parameter in the "Device information" menu the display will show the "Data overwriting" message. If the collected measurement results will be downloaded to a PC before memory is full, the warning message will not be displayed.

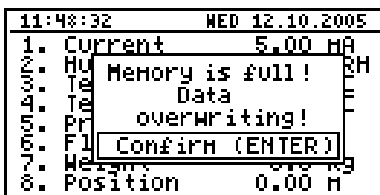

Fig. 7.16. Warning in “cyclic” recording mode

”Triggering” - method of recording measurement results. The following options are available:

- ”always” - measurements are recorded in time intervals defined by the “Recording period” parameter,
- ”high level” - measurements are recorded in time intervals defined by the “Recording period” parameter, only when the voltage of digital input is 24V,
- ”low level” - measurements are recorded in time intervals defined by the “Recording period” parameter, only when the voltage of digital input is 0V.

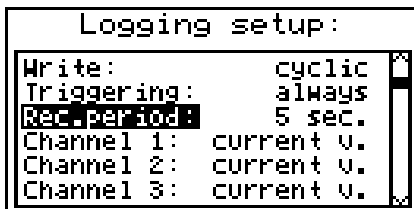

Fig. 7.17. “Logging setup” menu

”Rec.period” - this parameter defines the interval for measurement recording. 15 options are available: from **1 second to 1 hour**.



Measurements are synchronized with the unit’s internal real time clock, therefore when the “Recording period” parameter is set, for example, for 5 seconds the measurements will be executed for the fifth, tenth, fifteenth (etc.) second of each minute.

”Channel 1” ... ”Channel 8” - these options allow the type of value recorded in unit’s memory to be defined (the number of measurement channels available on the list depends on the unit version). The following values are available:

- ”disabled” - data from the selected measurement channel will not be recorded,
- ”current v.” - current values (corresponding to the results of current measurements) will be recorded for the selected measurement channel,

“average v.” - averaged values will be recorded for the selected measurement channel

(see section **MEASUREMENT MODE**, point 6.1.1).



If the **“Input type”** in the **“Inputs settings”** menu shall be set as **“disabled”** for a given channel, then this channel will not be available on the list of recording channels in the **“Logging setup”** menu.

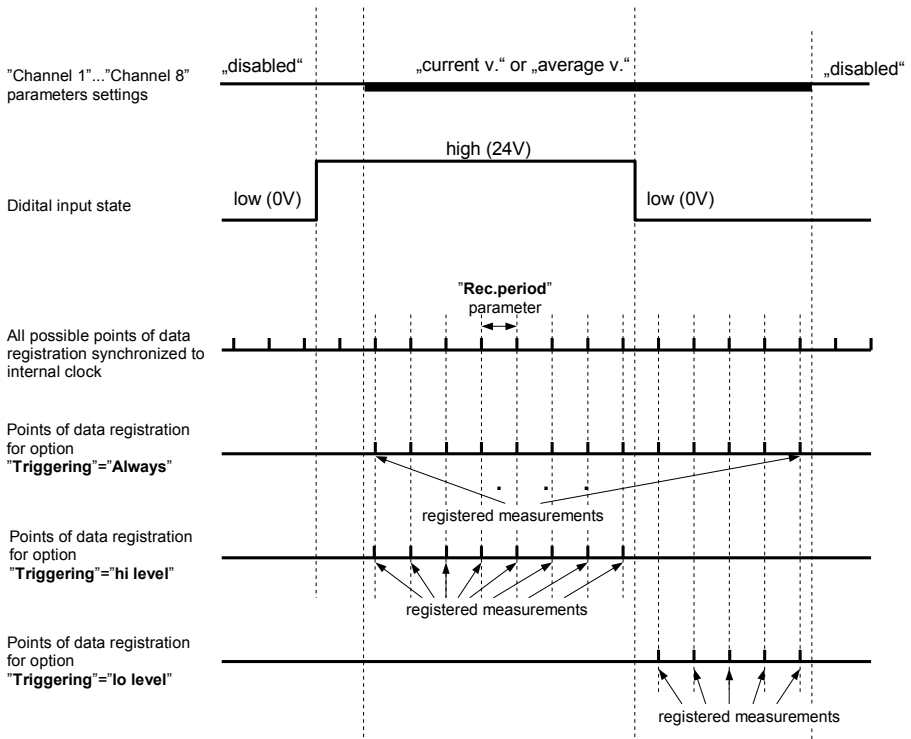

Fig. 7.18. Recording points depending on **“Triggering”** parameter value.

7.4.4. **“Input settings”** menu

This menu enables the configuring of current inputs. The number of the configured input is displayed in the upper part of the display (Fig. 7.19, 7.20). The following options are available in this menu:

“Name” - name assigned for the given channel (9-character sequence enabling identification of given channel),

“Unit” - 4-character sequence constituting the unit for the value measured on the given

channel.

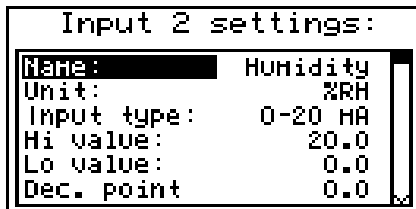

Fig. 7.19. "Inputs settings" (part 1)

"Input type" - type of input/sensor. The following options are available:

- "inactive" - input is not active
- "0-20 mA", "4-20 mA" - current inputs, displayed value is defined by "Hi value", "Lo value" and "Dec. point" parameters.

"Hi value" - these parameters define the values displayed for maximum (Hi), and
 "Lo value" - minimum (Lo) current in the selected measurement range (0-20 mA or 4-20 mA). The aforesaid parameters can be set in the range - 9999 ÷ 9999. A negative number can be input by entering a '-' mark (using [^], [v] keys).



The value of the "Lo value" parameter can be higher than the value of "Hi value" parameter. In such a case, for an increasing value of input current the displayed value decreases.

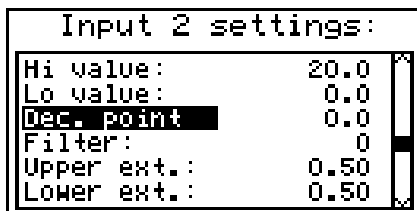

Fig. 7.20. "Inputs settings" menu (part 2)

"Dec. point" - position of the decimal point for results displayed in numerical form. The following options are available:

- "0"
- "0.0"
- "0.00"
- "0.000"

The position of the decimal point is selected with [^], [v] keys.

"Filter" - this option enables the level of the filtration of indications to be changed. Permissible values: from 0 (no filtration) to 5 (filtration with maximum time constant of approx. 2 seconds).

"Upper ext." - parameter defining the allowable range of input currents (Fig. 7.21).

"Lower ext." If the input current lies within the defined range then the appropriate measurement result shall be displayed despite exceeding the nominal measurement value 0-20 mA or 4-20 mA. If the input current exceeds the range defined by **"Upper extension"**, **"Lower extension"**, a **"-Hi-"** or **"-Lo-"** message (depending on the direction of exceeding the range) shall be displayed instead of the measurement result in numeric form. The **"Upper extension"** and **"Lower extension"** values are defined in mA with the accuracy of 0.01 mA. The **"Lower extension"** value is defined in relation to a 4 mA current, in the range of 0-3.99 mA (this parameter is significant only in the "4-20 mA" mode). The **"Upper extension"** value is defined in relation to a 20 mA current in the range of 0-1.99 mA.

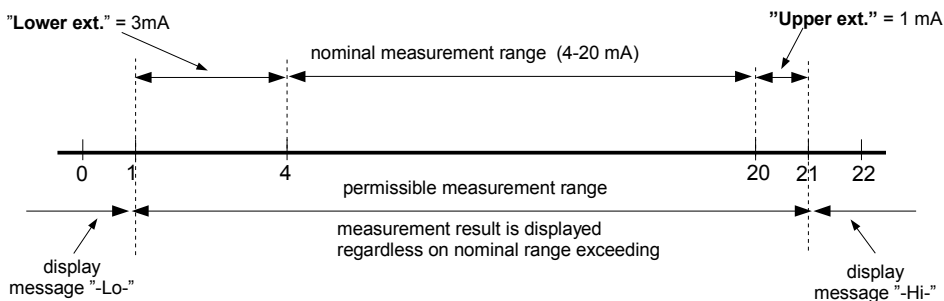

Fig. 7.21. Defining permissible measurement range for an example of settings of **"Upper ext."** and **"Lower ext."** parameters (for nominal measurement range 4-20 mA)

7.4.5. "Date & time settings" menu

Menu allows to change date and time of internal clock (RTC):

"Time" - current time according to the unit's real time clock,

"Date" - current date according to the unit's real time clock,

"Apply" - this option enables the internal real time clock to be set according to values of the **"Time"** and **"Date"** parameters.

After entering the menu the current indications of the internal clock are displayed. The changing of parameters (**"Time"** or **"Date"**) stops the indications updating. Changed parameters must be stored using the **"Apply"** option.



Reversing the Data Logger unit's clock (date and time) shall delete all data recorded by the unit, the recording time of which was later than the new time. In order not to lose the recorded data, it must be downloaded to a PC before the clock is reversed.



Fig. 7.22. "Date & time settings" menu

7.4.6. "RS485 port settings" menu

This menu contains options to configure the RS485 interface:

"Address" - this parameter specifies the unit's address, according to the Modbus protocol (in the range of 0 to 99). If the address is set as 0, then the unit responds to the FFh address.

"Baud rate" - this option defines the RS-485 serial interface transmission speed. 8 possibilities are available:
 "1200", "2400", "4800", "9600", "19200", "38400", "57600", "115200" b/sec.



Default baud rate value is 115200 b/sec. Some RS485 converters may not work properly with this setting. In such a case set lower baud rate (according to converter data sheet).

"Resp. delay" - this parameter defines minimal (additional) delay between the Modbus message and the answer of the device (received and sent via RS-485 interface). This additional delay allows the device to work with poor RS-converters which do not works properly on baud rates higher than 19200. This parameter can be set to one of values:

- "stand." - device responds without any additional delay
 - " +10 ch."
 - " +20 ch."
 - " +50 ch."
 - " +100 ch."
 - " +200 ch."
- } The unit response with additional delay equal to transmission time of 10, 20, 50, 100 or 200 characters.



In the most cases parameter **"Response delay"** should be set to **"Stand."** (no additional delay). Unfortunately for some third party RS-converters **"Response delay"** should be adjusted experimentally. Table below contains most frequently used values.

"Baud rate" parameter	"38400"	"57600"	"115200"
"Resp. delay" parameter	"+10 ch."	"+20 ch."	"+50 ch."

Tab. 7.1. Settings of **"Resp. delay"** parameter

"Conf. change" - this option allows the method of accessing unit's configuration registers through the RS485 interface to be defined.
The following options are available:

- "denied"** - configuration registers can not be set via RS-485 interface,
- "allowed"** - configuration registers can be set via RS-485 interface.

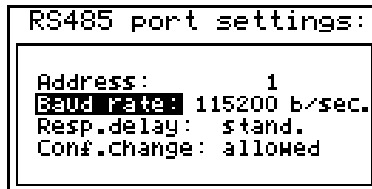

Fig. 7.23. **"RS485 port settings"** menu

7.4.7. "Access setup" menu

This menu contains options controlling access to the unit's adjustable parameters and to data downloading function (using USB Host port):

"Password for menu access" - menu access password (4-digit number). If the parameter is set to **"0000"** the password is disabled. If the parameter is different from **"0000"** then menu access requires password to be entered.

If the user do not remember his password, the access to the menu is possible by the **"one-use password"**. To get this password please contact with Marketing Division. Please set new user password immediately after use of the **"one-use password"**.

"Password for USB disk write" - password for data downloading to the flash disk (4-digit number). If the parameter is set to **"0000"** the password is disabled. If the parameter is different from **"0000"** then data downloading to **unregistered flash disk** - PenDrive requires password to be entered (registering can be done using **"Register the disk"** option).

"Register the disk" - this function allows registering (unregistering) single USB type FlashDrive (PenDrive). Data can be stored on **registered** flash drive without entering of the password.



Fig. 7.24. "Access setup" menu

7.4.8. "USB options" menu

This menu contains options which allows copying of device configurations between PC and data logger unit, and automatic data transfer using USB type FlashDrive (PenDrive):

"Write config. to disk" - this option allows writing device configuration to FlashDrive.

"Read config. from disk" - this option allows reading device configuration from FlashDrive.

After selection one of options above device waits for plugging in of FlashDrive. If disk is found then device displays the message which allows approving or cancelling selected operation.

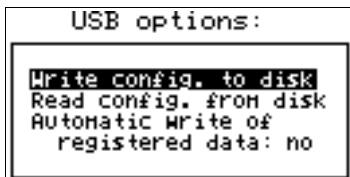

Fig. 7.25. "USB options" menu

To return to "USB options" menu, after finished reading or writing of configuration, FlashDrive should be unplugged or any key pressed.

If error occurs while reading or writing proper message is displayed. User have to confirm this message using [ENTER].

"Automatic write of registered data" - this option allows activating of automatic data storage to the Flash Drive plugged to USB socket.

Automatic data writing is made periodically, after recording about 70 kB of new data, what keeps the usage of internal memory below about 1%.

Autostorage frequency depends on recording settings (number of channels, and recording period). Minimum period between successive data storages is about 50 min. (8 channels recorded every 1 sec.).



- In case of error while auto data writing, device displays a proper message and waits for user acknowledge. While waiting for acknowledge, **DEVICE DOES NOT EXECUTE ANY AUTOSTORAGES**, but all data is recorded to internal

memory of the device. Due to the possibility of occurrence of: write error, FlashDrive or USB malfunction, and other incidental problems, autostorage function should be controlled by user from time to time. Lack of control can cause overwriting of data in internal memory or stopping of data recording due to impossibility of data storage on FlashDrive.

- If “**Password for USB disk write**” parameter has been set, then after power off / on sequence it is necessary to enter this password to run “Auto data write” function. To omit this requirement it is recommended to use function “**Register the disk**” or disable of “**Password for USB disk write**”.
- While “Auto data write” is active and FlashDisk is plugged to USB connector, pressing the **[ENTER]** key in any presentation mode will force the storage of current data to the Flash Drive (other functions of **[ENTER]** key are disabled). To allow default functions of **[ENTER]** button, it is necessary to unplug Flash Drive from USB connector.
- Depending on the recording settings, periods between successive storages can be long. To be sure that current data (up to now) had been written, force data storage (pressing **[ENTER]** in any data presentation mode) before disconnecting the Flash Drive from USB (see the previous note).

7.4.9. "Language" parameter

This parameter allows selection of messages and menu language.

7.5. MAIN MENU STRUCTURE

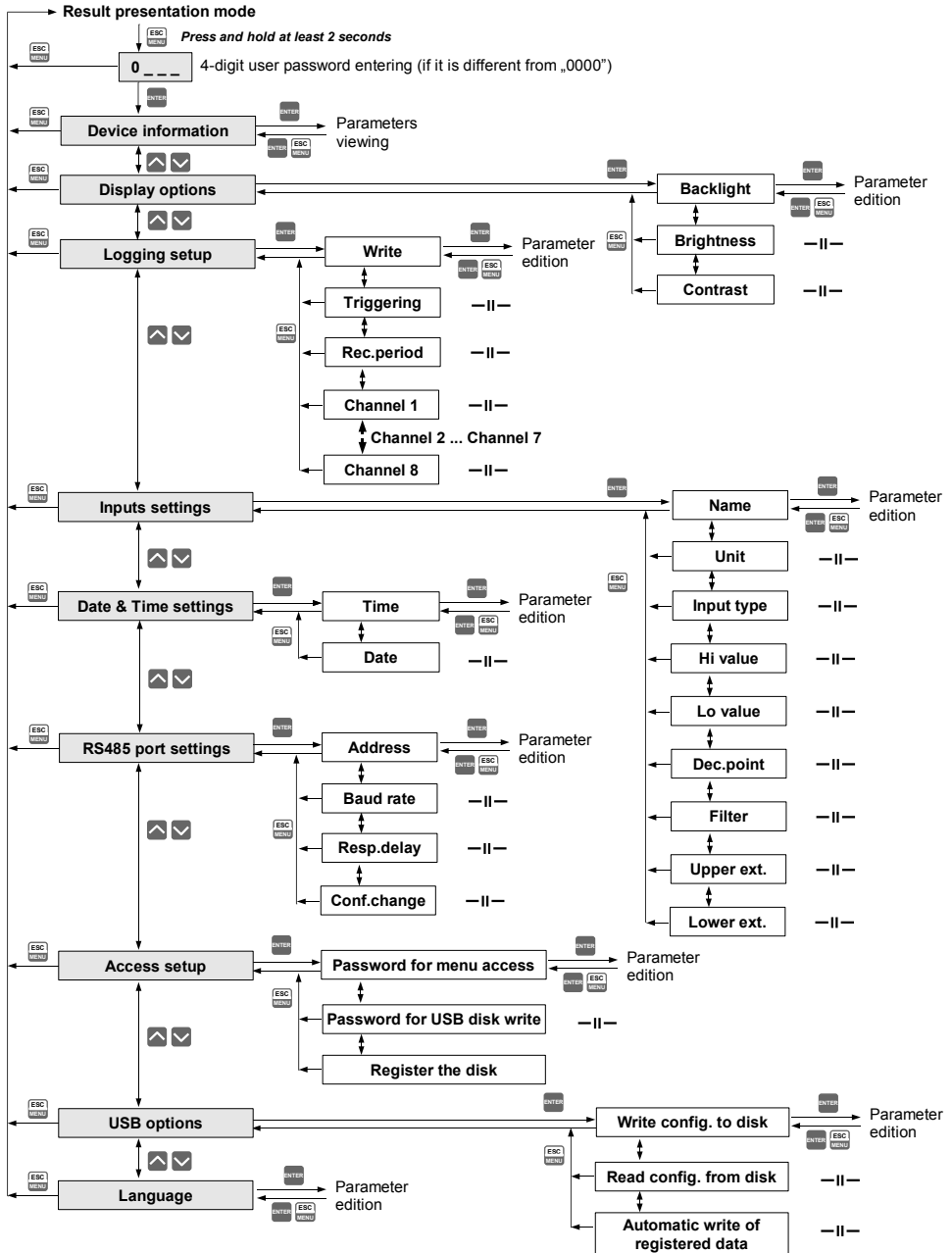

8. DOWNLOADING DATA FROM DATA LOGGER

8.1. MODBUS (RS485) DATA DOWNLOAD

To download data from the data logger connect it to PC via USB/RS485 or RS232/RS485 serial converter and use **Loggy Soft** delivered with the device. Description of **Loggy Soft** can be found in further chapter of this manual.

8.2. USB FLASH DRIVE (PENDRIVE) DATA DOWNLOAD

If data logger is equipped with USB Host interface, then the stored data can be downloaded from the data logger without **PC-PMS-90R** interconnection.



1. Before using a FlashDrive, format it in Windows system to FAT (recommended) or FAT32 file system (if FAT formatting is impossible). During formatting operation set the parameters according to the table below.

format	FAT		FAT32				
size	1GB	2GB	1GB	2GB	4GB	8GB	16GB
cluster	default	default	default	8KB	16KB	32KB	64KB

2. If data logger errors occur during read / write operation using FlashDrive, format it as shown in notice 1.
3. For FlashDrive greater than 16GB, proper read / write operations are not guaranteed.

To get data from the **PMS-90R** device plug a FlashDrive to USB Host port, located on the front panel of the device.

The following message will appear after a few seconds:

```

1. Input 1                               mA
2007.08.28 TUE 09:35:40                   0.9
2007.08.28 TUE 09:35:40                   0.9
2007.08.28 TUE 09:35:40                   0.9
Drive detected!                           0.9
Data Will be                               0.9
Written to disk!                           0.9
Confirm (ENTER)                            0.9
2007.08.28 TUE 09:35:48                   0.9
2007.08.28 TUE 09:35:48                   0.9
    
```

User can confirm ([**ENTER**] key) to start data downloading, or cancel the download ([**ESC/MENU**] key). FlashDrive device **MUST NOT** be removed during data downloading. Unexpected removal can cause a data corruption on the FlashDrive device.

Depending on the number of newly logged measurements, the data download time can vary from a few seconds to three minutes. A progress bar is displayed during the data write:



After successful data write the following message will appear:



In order to transfer logged data to the PC, connect FlashDrive to PC and use **Loggy Soft**. Description of **Loggy Soft** can be found in further chapter of this manual.

9. THE MODBUS PROTOCOL HANDLING

Transmission parameters: 1 start bit, 8 data bits, 1 stop bit, no parity control

Baud rate: selectable from: 1200 to 115200 bits/second

Transmission protocol: MODBUS RTU compatible

The device parameters and measurement result are available via RS-485 interface, as HOLDING-type registers of Modbus RTU protocol. The registers (or groups of the registers) can be read by 03h function, and wrote by 06h (single registers) or 10h (group of the registers) accordingly to Modbus RTU specification.

9.1. LIST OF REGISTERS

Register	Write	Range	Register description
01h ¹	No	-9999+9999	Measurement result for channel 1 (not considering the decimal point)
02h ¹	No	-9999+9999	Measurement result for channel 2 (not considering the decimal point)
03h ¹	No	-9999+9999	Measurement result for channel 3 (not considering the decimal point)
04h ¹	No	-9999+9999	Measurement result for channel 4 (not considering the decimal point)
05h ¹	No	-9999+9999	Measurement result for channel 5 (not considering the decimal point)
06h ¹	No	-9999+9999	Measurement result for channel 6 (not considering the decimal point)
07h ¹	No	-9999+9999	Measurement result for channel 7 (not considering the decimal point)
08h ¹	No	-9999+9999	Measurement result for channel 8 (not considering the decimal point)

Register	Write	Range	Register description
09h	No	0+0FFFFh	Information about exceeding the allowable measurement range on the given measurement channel in binary form: HGFEDCBAhgfedcba . Higher(2nd) byte - exceeding upper limit of measurement range (H - channel no 8, A - channel no 1). Lower(1st) byte - exceeding upper limit of measurement range (h - channel no 8, a - channel no 1). 1 - exceeding the range, 0 - measurement result within range
11h	Yes	0+1	"Backlight" parameter in "Display options" menu: 0 - permanent, 1 - temporary
12h	Yes	0+20	LCD backlight brightness
13h	Yes	0+20	LCD contrast
14h	Yes	0+3	"Language" parameter: 0 - Polish, 1 - English, 2 - French, 3 - Spanish
18h	No	0+6	Days of the week registry
19h	Yes	2000+2099	Year registry
1Ah	Yes	1+12	Months registry
1Bh	Yes	1+31	Days registry
1Ch	Yes	0+23	Hours registry
1Dh	Yes	0+59	Minutes registry
1Eh	Yes	0+59	Seconds registry
1Fh	Yes	0+3	Control registry for time-related settings: 0 - startup of continued update of registries 18h + 1Eh by internal clock (current time and date), 80h - stopping update of registries 18h + 1Eh by internal clock (automatically after writing one of 18h + 1Eh registries). In this status 18h + 1Eh registries can be written with new values in order to update internal clock settings. Updating the clock settings with contents of 18h + 1Eh registries can be executed by sending the following commands to the control registry: 1 - hour update on the basis of (1Ch + 1Eh) registries' contents; 2 - date update on the basis of (18h + 1Bh) registries' contents; 3 - time and date update on the basis of (18h + 1Eh) registries' contents. After sending commands 1 , 2 or 3 the contents of registries automatically return to 0.
20h ²	Yes	0+199	Address of device
21h	No	007Ah	Device identification code
22h ³	Yes	0+7	"Baud rate" parameter in "RS485 port settings" menu (baud rate): 0 - 1200; 1 - 2400; 2 - 4800; 3 - 9600; 4 - 19200; 5 - 38400; 6 - 57600; 7 - 115200;
23h ⁴	Yes	0+1	"Conf. change" parameter in "RS485 port settings" menu (permission to write registers): 0 - write denied; 1 - write allowed.
28h	No		Firmware version
29h	No		Compilation number

Register	Write	Range	Register description
2Ah	No		Higher (2 nd) word of serial number
2Bh	No		Lower (1 st) word of serial number
2Ch	No	1, 4, 8	Number of units' measurement channels
2Dh	No		Size of unit's memory for recording in kB.
30h	Yes	0÷255	Activation of logging for selected channel (binary): 00000000 hgfedcba (h – channel no 8, a – channel no 1): 0 – logging On; 1 – logging Off.
31h	Yes	0÷2	"Triggering" parameter in "Logging setup" submenu: 0 - always; 1 - hi level, 2 - lo level
32h	Yes	0÷14	"Rec. period" parameter in "Logging setup" submenu: 0 - 1 sec.; 1 - 2 sec.; 2 - 5 sec.; 3 - 10 sec.; 4 - 15 sec.; 5 - 20 sec.; 6 - 30 sec.; 7 - 1 min.; 8 - 2 min.; 9 - 5 min.; 10 - 10 min.; 11 - 15 min.; 12 - 20 sek.; 13 - 30 min.; 14 - 60 min.
33h	Yes	0÷1	"Write" parameter in "Logging setup" submenu: 0 - until full; 1 - cyclic
34h	Yes	0÷255	Activation of averaging for selected channel (binary): 00000000 hgfedcba (h - channel no 8, a - channel no 1): 0 - averaging off; 1 - averaging on;
38h	No		Written memory in kB
39h	No		Approximated time remaining until memory is filled with recorded measurement results – Higher (2 nd) byte (parameter in seconds).
3Ah	No		Approximated time remaining until memory is filled with recorded measurement results – Lower (1 st) byte (parameter in seconds).
Configuration parameters for channel No. 1			
40h	Yes	0÷2	"Input type" parameter in "Inputs settings" submenu for channel 1: 0 - inactive; 1 - 0-20mA; 2 - 4-20mA
41h	Yes	-9999÷9999	"Lo value" parameter in "Inputs settings" submenu for channel 1 (not considering decimal point)
42h	Yes	-9999÷9999	"Hi value" parameter in "Inputs settings" submenu for channel 1 (not considering decimal point)
43h	Yes	0÷3	"Dec. point" parameter in "Inputs settings" submenu for channel1: 0 - 0; 1 - 0,0; 2 - 0,00; 3 - 0,000
44h	Yes	0÷5	"Filter" parameter in "Inputs settings" submenu for channel 1: (filtration coefficient)
45h	Yes	0÷399	"Lower ext." parameter in "Inputs settings" submenu for channel 1 expressed in 0.01 mA (not considering decimal point)
46h	Yes	0÷199	"Upper ext." parameter in "Inputs settings" submenu for channel 1 expressed in 0.01 mA (not considering decimal point)
47h	Yes	Character	"Name" parameter in "Inputs settings" submenu for channel 1; Higher byte – character No. 1; Lower byte – character No. 2
48h	Yes	Character	"Name" parameter in "Inputs settings" submenu for channel 1; Higher byte – character No. 3; Lower byte – character No. 4

Register	Write	Range	Register description
49h	Yes	Character	“Name” parameter in “Inputs settings” submenu for channel 1; Higher byte – character No. 5; Lower byte – character No. 6
4Ah	Yes	Character	“Name” parameter in “Inputs settings” submenu for channel 1; Higher byte – character No. 7; Lower byte – character No. 8
4Bh	Yes	Character	“Name” parameter in “Inputs settings” submenu for channel 1; Higher byte – character No. 9; Lower byte – 0
4Ch	Yes	Character	“Unit” parameter in “Inputs settings” submenu for channel 1; Higher byte – character No. 1; Lower byte – character No. 2
4Dh	Yes	Character	“Unit” parameter in “Inputs settings” submenu for channel 1; Higher byte – character No. 3; Lower byte – character No. 4
Register from 50h to 5Dh			Parameters in “Inputs settings” submenu for channel 2; registry description like for channel 1 (see registers 40h do 4Dh).
Register from 60h to 6Dh			Parameters in “Inputs settings” submenu for channel 3; registry description like for channel 1 (see registers 40h do 4Dh).
Register from 70h to 7Dh			Parameters in “Inputs settings” submenu for channel 4; registry description like for channel 1 (see registers 40h do 4Dh).
Register from 80h to 8Dh			Parameters in “Inputs settings” submenu for channel 5; registry description like for channel 1 (see registers 40h do 4Dh).
Register from 90h to 9Dh			Parameters in “Inputs settings” submenu for channel 6; registry description like for channel 1 (see registers 40h do 4Dh).
Register from A0h to ADh			Parameters in “Inputs settings” submenu for channel 7; registry description like for channel 1 (see registers 40h do 4Dh).
Register from B0h to BDh			Parameters in “Inputs settings” submenu for channel 8; registry description like for channel 1 (see registers 40h do 4Dh).

- 1 if the measurement result exceeds the allowable measurement range defined by “Hi value”, “Lo value” and “Upper ext.”, “Lower ext.” parameters then 01h + 08h registries shall contain limit values for the allowable range.
 - 2 Exceeding the allowable measurement range shall be signalled by setting appropriate bits of the 09h registry.
 - 3 after writing registry 20h the unit replies with the frame starting from the old (unchanged) address
 - 4 after writing registry 22h the unit replies with the frame sent according to the new baud rate
- status of “Triggering” parameter in “RS485 port settings” submenu also relates to the writing of this parameter; therefore it is possible to block writing of all registries using the RS485 port, but unblocking can be made only through the device's menu.

9.2. TRANSMISSION ERRORS HANDLING

If during reading or writing one of registries an error occurs then the unit shall return the frame containing the error code (according to the Modbus protocol, see: example No. 5, page 53).

Error codes should be interpreted as follows:

01h - illegal function (only functions 03h, 06h and 10h are available),

02h - illegal register address

03h - illegal data value

08h - no write permission (see: “Config change” parameter in the “RS485 port settings” menu)

9.3. EXAMPLES OF QUERY/ANSWER FRAMES

The examples concern a unit with address 1. All values are given in the hexadecimal system. Designations:

- ADDR** Address of the device in the system
FUNC Function number
REG H,L Higher and lower part of registry number, to which the command refers to
COUNT H,L Higher and lower part of registry counter number, to which the command refers
BYTE C Number of higher bytes in the frame
DATA H,L Higher and lower part of data word
CRC L,H Higher and lower part of CRC sum

1. Read of ID code

ADDR	FUNC	REG H,L		COUNT H,L		CRC L,H	
01	03	00	21	00	01	D4	00

The answer:

ADDR	FUNC	BYTE C	DATA H,L		CRC L,H	
01	03	02	00	7A	39	A7

DATA H,L - identification code (007Ah)

2. Change of the device address from 1 to 2 (write to reg. 20h)

ADDR	FUNC	REG H,L		DATA H,L		CRC L,H	
01	06	00	20	00	02	09	C1

DATA H - 0

DATA L - new device address (2)

The answer (the same as the message):

ADDR	FUNC	REG H,L		DATA H,L		CRC L,H	
01	06	00	20	00	02	09	C1

3. Read of the displayed value (measurement) for channel 1, the device address = 01h:

ADDR	FUNC	REG H,L		COUNT H,L		CRC L,H	
01	03	00	01	00	01	D5	CA

The answer:

ADDR	FUNC	BYTE C	DATA H,L		CRC L,H	
01	03	02	00	FF	F8	04

DATA H, L - displayed value = 255, no decimal point. Decimal point position can be read from reg. 43h (position of decimal point for channel 1)

4. Read of the registers 1, 2 and 3 in one message (example of reading a number of registries in one frame):

ADDR	FUNC	REG H,L		COUNT H,L		CRC L,H	
01	03	00	01	00	03	54	0B

COUNT L - the count of being read registers (max. 32)

The answer:

ADDR	FUNC	BYTE C	DATA H1,L1		DATA H2,L2		DATA H3,L3		CRC L,H	
01	03	06	00	0A	00	02	02	80	18	74

DATA H1, L1 - 01h registry (10 – value displayed for channel 1, no decimal point),
 DATA H2, L2 - 02h registry (2 – value displayed for channel 2, no decimal point),
 DATA H3, L3 - 03h registry (640 – value displayed for channel 3, no decimal point).

**5. Setting of name for channel 1 as "Channel 1 "
 (example of writing a number of registries in one frame)**

ADDR	FUNC	REG H,L		COUNT H,L		BYTE C
01	10	00	47	00	05	0A

continue of frame:

DATA H1,L1		DATA H2,L2		DATA H3,L3		DATA H4,L4		DATA H5,L5		CRC L,H	
43	68	61	6E	6E	65	6C	20	31	20	7F	D0

DATA H1, L1 - 47h registry (43h - character "C", 68h - character "h"),
 DATA H2, L2 - 48h registry (61h - character "a", 6Eh - character "n"),

DATA H3, L3 - 49h registry (6Eh - character "n", 65h - character "e"),
 DATA H4, L4 - 4Ah registry (6Ch - character "l", 20h - space " "),
 DATA H5, L5 - 4Ah registry (31h - character "1", 20h - space " ").

a) The answer (we assume that input current is not out of range):

ADDR	FUNC	REG H,L		COUNT H,L		CRC L,H	
01	10	00	47	00	05	B0	1F

b) The answer (if an error occur):

ADDR	FUNC	ERR	CRC L,H	
01	90	08	4D	C6

ERR - error code (08 - registry writing blocked by "Config change" parameter in "RS485 port settings" menu)

6. Change of baud rate of all devices connected to the net (BROADCAST message).

ADDR	FUNC	REG H,L		COUNT H,L		CRC L,H	
00	06	00	22	00	04	29	D2

DATA H - 0

DATA L - 4, new baud rate 19200 baud

Device do not reply to BROADCAST-type messages.



There is no full implementation of the Modbus Protocol in the device. The functions presented above are available only.

10. USER'S SETTINGS LIST

Parameter	Description	Value	Description page
Parameters in the "Measurements list options" menu			
List type	Type of measurement results list		32
Date, Time	Position of time line on historical list		33
Parameters in the "Graph options" menu			
Scale	Setting time scale		33
Parameters in the "Channels list options" menu			
Display	Method of displaying results		34
Parameters in the "Device information" menu			
Version	Device firmware version		35
Serial no	Device serial number		35
Memory	Available device's memory		35
Used	Used memory		35
Time left	Time until memory is full		35
Parameters in the "Display options" menu			
Backlight	Method of display backlight operation		36
Brightness	Brightness of display backlight		36
Contrast	Display contrast		36
Parameters in the "Logging setup" menu			
Write	Recording mode		37
Triggering	Method of measurement recording, digital input function		38
Rec. period	Time interval for measurement recording		38
Channel 1	Type of recorded value		38
Channel 2	Type of recorded value		38
Channel 3	Type of recorded value		38
Channel 4	Type of recorded value		38
Channel 5	Type of recorded value		38
Channel 6	Type of recorded value		38
Channel 7	Type of recorded value		38
Channel 8	Type of recorded value		38
Settings for Channel 1 in "Inputs settings" menu			
Name	Measurement channel name		39

Parameter	Description	Value	Description page
Unit	Unit for measured value		39
Input type	Type of input/sensor		40
Hi value	Value displayed for maximum value of input current		40
Lo value	Value displayed for minimum value of input current		40
Dec. point	Position of the decimal point		40
Filter	Level of filtration of indications		41
Upper ext.	Upper extension of measurement range		41
Lower ext.	Lower extension of measurement range		41
Settings for Channel 2 in "Inputs settings" menu			
Name	Measurement channel name		39
Unit	Unit for measured value		39
Input type	Type of input/sensor		40
Hi value	Value displayed for maximum value of input current		40
Lo value	Value displayed for minimum value of input current		40
Dec. point	Position of the decimal point		40
Filter	Level of filtration of indications		41
Upper ext.	Upper extension of measurement range		41
Lower ext.	Lower extension of measurement range		41
Settings for Channel 3 in "Inputs settings" menu			
Name	Measurement channel name		39
Unit	Unit for measured value		39
Input type	Type of input/sensor		40
Hi value	Value displayed for maximum value of input current		40
Lo value	Value displayed for minimum value of input current		40
Dec. point	Position of the decimal point		40
Filter	Level of filtration of indications		41
Upper ext.	Upper extension of measurement range		41
Lower ext.	Lower extension of measurement range		41
Settings for Channel 4 in "Inputs settings" menu			
Name	Measurement channel name		39

Parameter	Description	Value	Description page
Unit	Unit for measured value		39
Input type	Type of input/sensor		40
Hi value	Value displayed for maximum value of input current		40
Lo value	Value displayed for minimum value of input current		40
Dec. point	Position of the decimal point		40
Filter	Level of filtration of indications		41
Upper ext.	Upper extension of measurement range		41
Lower ext.	Lower extension of measurement range		41
Settings for Channel 5 in "Inputs settings" menu			
Name	Measurement channel name		39
Unit	Unit for measured value		39
Input type	Type of input/sensor		40
Hi value	Value displayed for maximum value of input current		40
Lo value	Value displayed for minimum value of input current		40
Dec. point	Position of the decimal point		40
Filter	Level of filtration of indications		41
Upper ext.	Upper extension of measurement range		41
Lower ext.	Lower extension of measurement range		41
Settings for Channel 6 in "Inputs settings" menu			
Name	Measurement channel name		39
Unit	Unit for measured value		39
Input type	Type of input/sensor		40
Hi value	Value displayed for maximum value of input current		40
Lo value	Value displayed for minimum value of input current		40
Dec. point	Position of the decimal point		40
Filter	Level of filtration of indications		41
Upper ext.	Upper extension of measurement range		41
Lower ext.	Lower extension of measurement range		41
Settings for Channel 7 in "Inputs settings" menu			
Name	Measurement channel name		39

Parameter	Description	Value	Description page
Unit	Unit for measured value		39
Input type	Type of input/sensor		40
Hi value	Value displayed for maximum value of input current		40
Lo value	Value displayed for minimum value of input current		40
Dec. point	Position of the decimal point		40
Filter	Level of filtration of indications		41
Upper ext.	Upper extension of measurement range		41
Lower ext.	Lower extension of measurement range		41
Settings for Channel 8 in "Inputs settings" menu			
Name	Measurement channel name		39
Unit	Unit for measured value		39
Input type	Type of input/sensor		40
Hi value	Value displayed for maximum value of input current		40
Lo value	Value displayed for minimum value of input current		40
Dec. point	Position of the decimal point		40
Filter	Level of filtration of indications		41
Upper ext.	Upper extension of measurement range		41
Lower ext.	Lower extension of measurement range		41
Parameters in the "RS485 port settings" menu			
Address	Device address		42
Baud rate	Baud rate		42
Resp. delay	Delay of device response		42
Conf. change	Permission for modifying unit's parameters through RS485 interface		43
Parameters in the "USB options" menu			
Automatic write of registered data	Permission for auto data write		44
Language	User interface language		45

II. USER MANUAL FOR “LOGGY SOFT”



designed for
Windows

System requirements:

At least i486 computer,
Windows® 95/98/ME/2000/XP
Colour monitor with minimum resolution of 640 x 480,
20 MB of free hard drive space.

1. GENERAL CHARACTERISTICS

The **Loggy Soft** program enables the visualization, archiving and printing of measurements (e.g. temperature, humidity, pressure) stored in **PMS-90R**-type device memory. Work with **PMS-90R**-type devices takes place through an RS485 serial interface, or via the USB FlashDrive (PenDrive) device (optional interface of **PMS-90R**). Connecting a network of units to a serial port (RS 232) or USB port of a PC is possible using a proper converter (RS 485 to RS 232 or RS 485 to USB).

2. INSTALLATION AND STARTUP

The **LoggySoft-install** file is designed to install the program. The install file is located in **Loggy Soft** folder on CD delivered with device.

During installation follow the directions provided by **Installation wizard**. The wizard will create a folder called **Loggy Soft** on the computer's hard drive, the program files will be placed in this folder. The shortcut to the program will be placed in a location specified by the user.

Manual startup of the program is done using the **Loggy.exe** executable file.

Initial startup of the application enables detection of all **PMS-90R**-type devices present in the network. The user is asked to perform an **PMS-90R** devices installation and measurement channel configuration procedure for all detected devices.

Follow the guidelines in the windows displayed by the program.

WARNING! There is no need of detecting the devices using USB FlashDisk data download at this point. Devices of that kind will be detected and installed later, during the first data download. If the system consist of FlashDisk-served devices only, you can skip the following installation steps by pressing **[FLASH DRIVE only]** button.

To continue installation procedure, click on the **[Next>>]** button. The next screen (Fig. 2.1) enables the selection of the number for the RS 232 serial port for the converter, and the transmission speed. The number of chosen for the selected port must comply with number of the port to which the converter is connected.

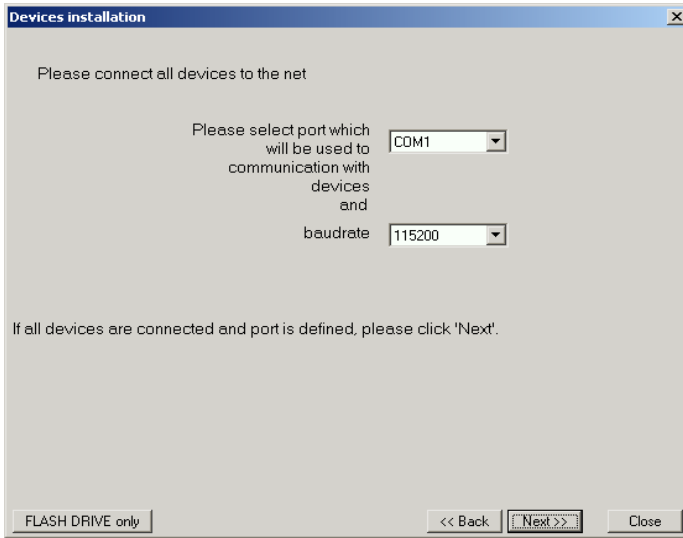

Fig. 2.1. Selection of serial port and baud rate

After defining the communications port and baud rate, go to device detection screen (Fig. 2.2) by clicking on the **[Next>>]** button.

Prior to scanning the network for devices, set the addresses identifying the selected **PMS-90R** devices in the network (a different address for each device – see page 42). In order to detect units connected to the network (after assigning addresses to the devices) press the **[Scan network]** button.



Address set in the unit should be in 1÷254 range. Devices with not changed address will not be found by software !

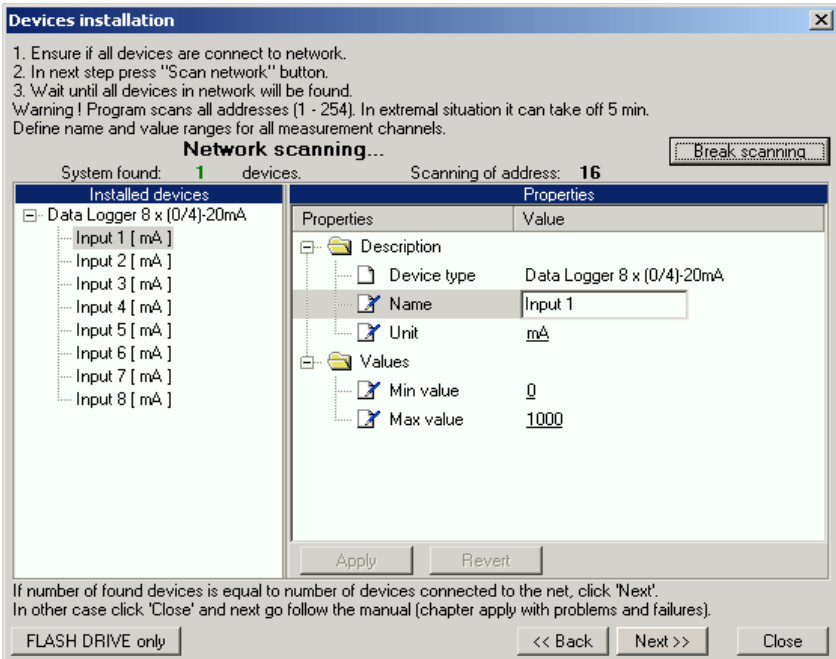

Fig. 2.2. Scanning network for devices

The list shown on the figure (Fig. 2.2) contains one detected device. Order of devices on the list corresponds to the order of addresses assigned by the user to individual **PMS-90R** devices. Once all devices are detected press **[Break scanning]** button.

„**Properties**” list available in right part of the window allows configuration of measurement channels. Appropriate names (e.g. the location where the sensor connected to this channel was installed), unit denotation and allowable measured values (minimum and maximum) should be assigned to measurement channels of detected devices. In case these values are exceeded during system operation an alarm message will be displayed.

After pressing the **[Next>>]** button the final installation screen will be displayed.

3. USING THE PROGRAM

Upon application startup the **Current measure** menu is displayed (Fig. 3.1).

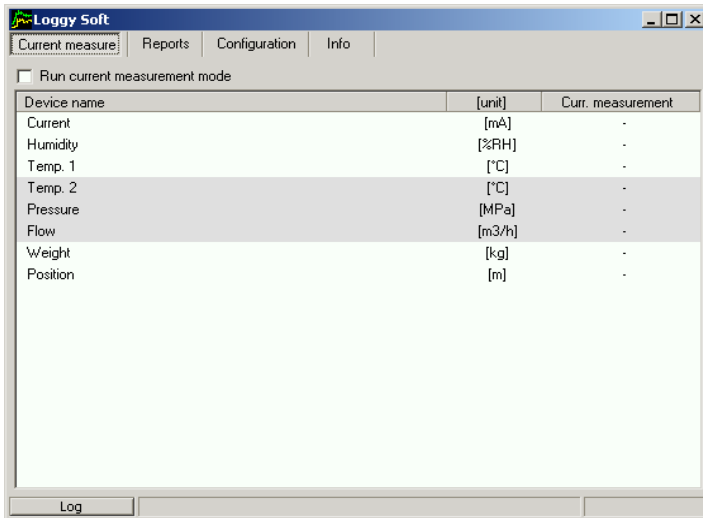

Fig. 3.1 Program window upon startup

The selection from the currently active menu is made using the flat buttons in the upper part of the program window (Fig. 3.1). Three positions are available:

- **Current measure** - menu for current measurements visualizing;
- **Reports** - menu for visualizing and printing reports;
- **Configuration** - menu for changing system settings and defining measurement channel groups;
- **Info** - menu containing program information.

Button **[Log]** located in bottom part of the main window allows opening/closing additional window with messages related to the program execution. These messages window is opened automatically when new message appears.

3.1. „CURRENT MEASURE” MENU

Current measures menu allows to view current measurements results in table format. This table contains measures of channels of all installed **PMS-90R** units. Only the measurements from devices installed using the RS485 interface will be available. To enable continuous reading of data from the devices check **Enable current measurement mode**. Presently read data will be showed in column named **Current measurement**.

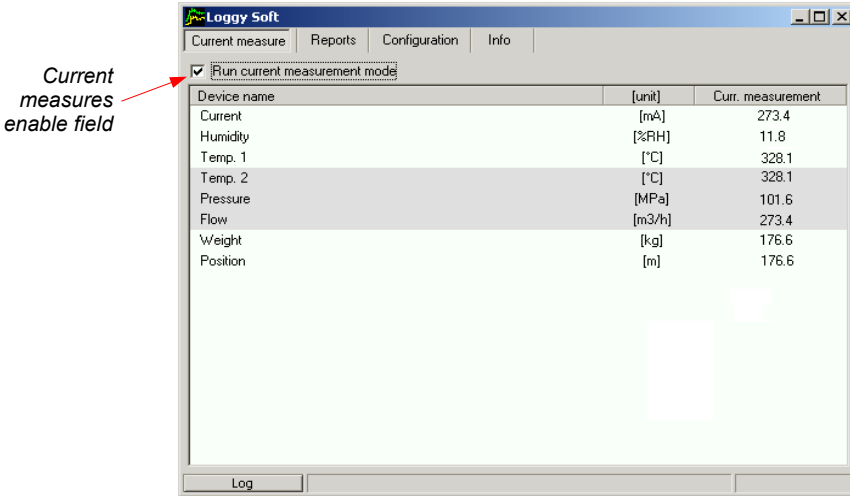

Fig. 3.2. **Current measure** menu

3.2. „REPORTS” MENU

Reports menu is used to view and print reports containing recorded measurement results in the form of tables or graphs. This menu also enables export of measurement data to a text format file.

Creating new reports is possible in two modes:

- for a group (collective report for a maximum of 12 measurement channels),
- for a single channel.



Creating a report for a channel belonging to a removed device is possible only in single channel mode.

3.2.1...**Table** tab

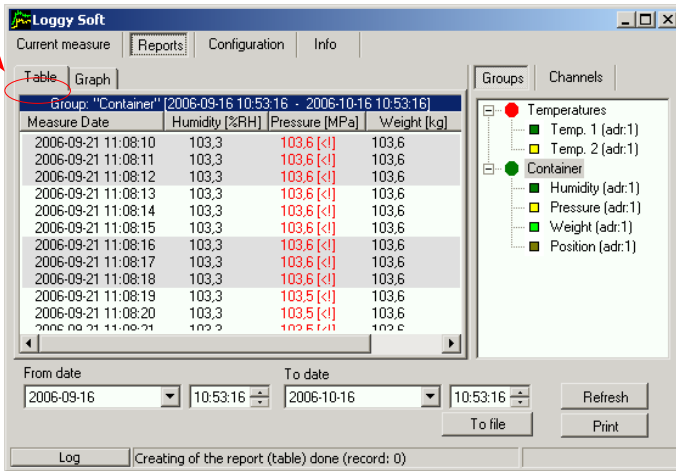

Fig. 3.3. **Reports** - menu

The **Table** tab (Fig. 3.3) is used for printing information concerning recorded measurements (e.g. temperature, humidity) in the form of a table for one of the groups or a particular measurement channel selected by the user (for more information on groups see 3.3.2 section, at page 73). This tab also enables the export of data to text format files. The exported file is formatted in a way allowing the transfer of data to a calculation sheet.

A table consisting of columns containing measurement date and value (for one or a number of channels) is displayed in the centre of the tab. The remaining elements of the **Table** tab are:

- **From date** - this is the date and time defining the beginning of analysed measurement recording period for printing in the form of a table,
- **To date** - this is the date and time defining the end of analysed measurement recording period for printing in the form of a table (this does not have to be the current date),
- **[Print]** button - prints the report,
- **[Refresh]** button - updates the displayed data
- **[To file]** button - exports data to a text file
- **Groups/Channels** - this box enables creating tables in two modes:
 - for a group - collective table for a maximum of 12 measurement channels (observed channels can belong to different **PMS-90R** devices),
 - for a single channel.



Creating groups is described in the **Group operations** section (page 73).

Selecting table type (for a group or single channel)

In order to select table type:

- click appropriate tab **Groups** or **Channels** (Fig. 3.3),
- check specific group or measurement channel. This will display measurement results for the selected group or single channel (displaying results takes place automatically after each change of group or measurement channel).



In order to use table for groups the group must be created first. Creating groups is described in the **Group operations** section (3.3.2, page 73).

Change of "From date" or "To date"

- 1) In order to change "From date" or "To date" date, click onto the arrow on right side of the date (Fig. 3.4). The calendar window will open:

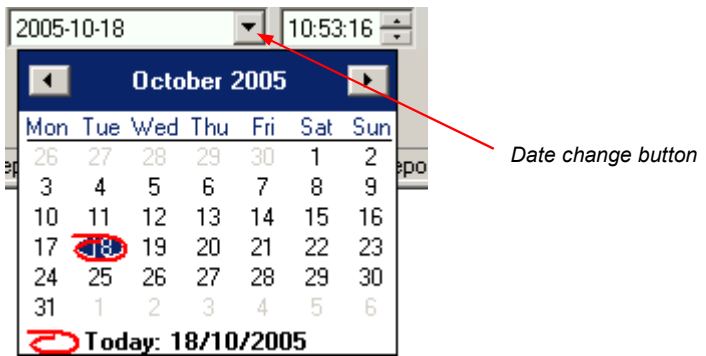

Fig. 3.4. Changing the "From date"

- 2) The date can be change by clicking onto any day in the calendar. Buttons at the top part of the calendar are used to change months (Fig. 3.5). After clicking on the current year located to the right from month's name an edition window and buttons for changing the year are displayed (Fig. 3.5).

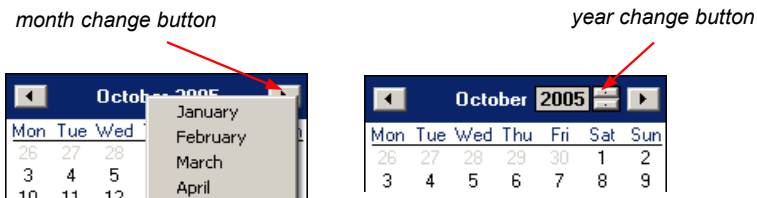

Fig. 3.5. Changing months and year

- 3) The time can be changed by clicking on the box, in which it is displayed and manually typing it in using the keyboard.
- 4) The operation is completed by pressing the **[Refresh]** button; this will update the data shown in the table.

3.2.2...*Graph* tab

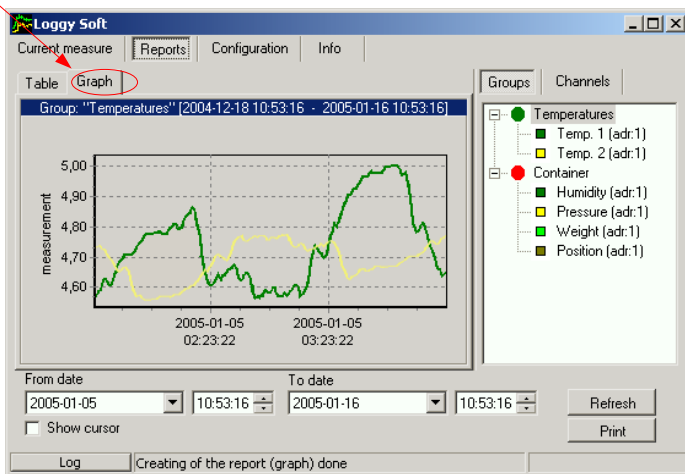

Fig. 3.6. Reports - *Graph* tab

Graph tab (Fig. 3.6) is used for viewing and printing of measurement results recorded by an **PMS-90R** device (e.g. temperature, humidity) in the form of a graph. Measurements from a maximum of five recorded measurement channels can be viewed.

The **Graph** tab contains such elements as:

- **graphs area** - plots measured values (e.g. temperature, humidity) in function of time. Each channel is distinguished by a different colour (Fig. 3.6);
- **From date** - this is the date and time defining the beginning of analysed measurement recording period for printing in the form of a graph;
- **To date** - this is the date and time defining the end of analysed measurement recording period for printing in the form of a graph (this does not have to be the current date);
- **[Print]** button - prints the report;

- **[Refresh]** button - updates the displayed data;
- **Show cursor** field - check this field to activate special graphical cursor which allows to track measurement points of the selected channel graph.
- **Groups/Channels**
 - for a group
 - collective graph for a maximum of 12 measurement channels (observed channels can belong to different **PMS-90R** devices);
 - for a single channel.



Creating groups is described in the **Group operations** section (3.3.2, page 73).

Selecting graph type (for a group or single channel)

In order to select table type:

- click appropriate tab **Groups** or **Channels** (Fig. 3.6),
- check specific group or measurement channel. This will display measurement results for the selected group or single channel (displaying results takes place automatically after each change of group or measurement channel).



In order to use table for groups the group must be created first. Creating groups is described in the **Group operations** section (3.3.2, page 73).

Change of “From date” or “To date”

Change of start and end date take place the same way as in **Table** tab (see page 65).

Changing the graph display method

Following operations are available for the **graph area**:

- **enlarge graph** - a graph can be enlarged by marking the area of interest with the mouse pointer. In order to do this first left-click on the graph and, while holding down the left mouse button, drag the pointer to the bottom right corner of the graph. The rectangle marked this way will be enlarged (Fig. 3.7).

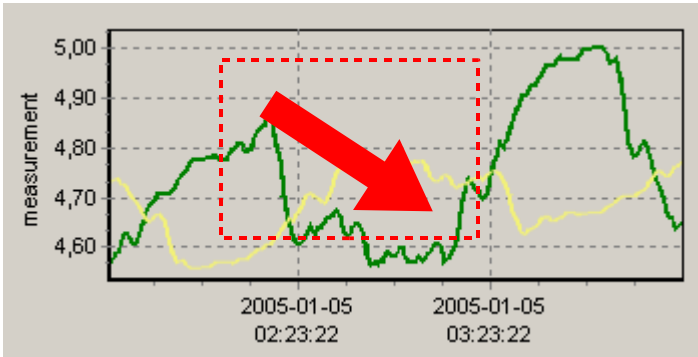

Fig. 3.7. Enlarging graph

- **moving the graph** - the graph can be moved to the left/right (earlier/later time period, correspondingly). In order to do this, right-click on the graph and drag the pointer in desired direction (Fig. 3.8).

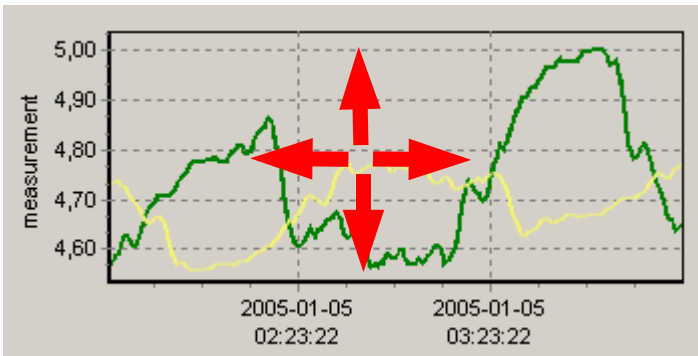

Fig. 3.8. Moving the graph

- **measurement points tracking** - if **Show cursor** field is checked then special graphical cursor is displayed on the graph. This cursor allows to easy tracking of measured data. Colour of the cursor is same as selected channel colour. To change selection click left mouse button until cursor became same colour as desired channel. Near to the cursor informations about selected point are displayed. Date and time of recording and value of the registered measurement point.



Fig. 3.9. Graph with special tracking cursor

- **restoring default values initial** - the **[Refresh]** button enables returning to graph in 1:1 scale;
- **update the displayed measurements** - the **[Refresh]** button allows to update measurement data displayed on the graph.

Information on periodical lack of measurement

If any measurement channel, for whatever reasons (e.g. sensor fault), will not record measurement values, then this situation will be presented on the graph as **interruption** in the measurement (Fig. 3.10).



Fig. 3.10. Interruption in the graph (e.g. sensor fault)

If measurements can not be executed for some time (e.g. power supply fault or the **PMS-90R** device is switched off) then the program will show this situation on the graph in the form of two vertical lines (Fig. 3.11).

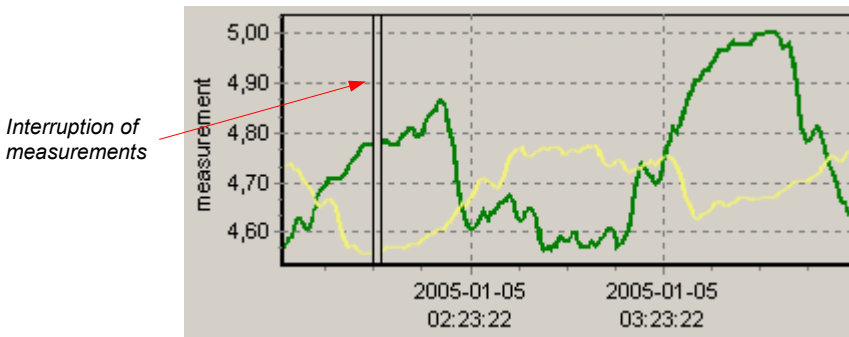

Fig. 3.11. Vertical lines on the graph - interruption of measurements



Prior to analysing recorded measurement results, read the current data recorded by **PMS-90R** devices. In order to download current data recorded by **PMS-90R** devices press the **[Download data (RS 485)]** button in the **Devices** tab in the **Configuration** menu, or alternatively insert the USB FlashDrive (PenDrive) with logged data to PC USB port and confirm the data download. The database of recorded measurements will be updated.

3.3. „CONFIGURATION” MENU

The **Configuration** menu is used to:

- change the settings of channels of **PMS-90R** devices working in the system and getting data from these devices (**Devices** tab);
- operations of groups (**Groups** tab).

3.3.1.„Devices” tab

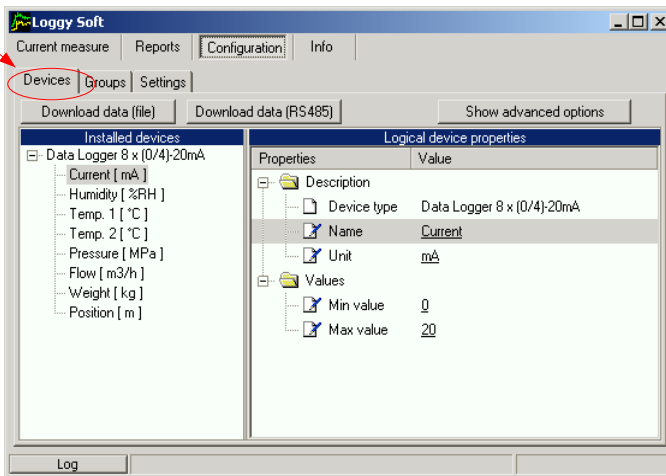

Fig. 3.12. Configuration – Devices tab (advanced options hidden)

Changing of devices settings

The settings of devices can be changed by clicking on the **Devices** tab (Fig. 3.12). Parameters in this tab can be edited after clicking on **[Show advanced options]** button. The user will be asked to enter a password protecting against the changing of the settings by an unauthorized person. Entering of proper password allows to edit parameters and displaying of additional keys for devices adding / removing (Fig. 3.13). The password is supplied together with the **Loggy Soft** program.

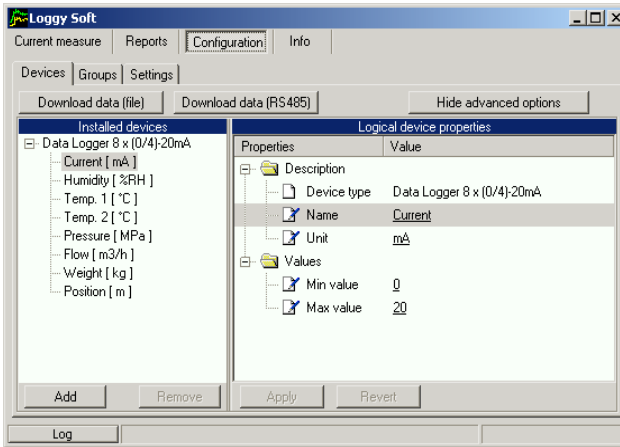

Fig. 3.13. **Configuration - Devices tab (advanced options active)**

The **Devices** tab (Fig. 3.13) contains such elements (fields) as:

- Installed devices** - shows the tree contains a list of all currently installed **PMS-90R** devices together with their addresses. The first level of the tree shows individual **PMS-90R** devices. After clicking the “+” sign next to the **PMS-90R** device name with mouse pointer, the measurement channels corresponding to this device are displayed. By clicking on one of **PMS-90R** devices we can see measurement channels under names defined during system installation (e.g. “Flow”).
- ...device properties** - shows the tree containing a list of properties of selected device or channel. All parameter's values (underlined) can be edited. All changed but not approved (using **[Apply]**) values are showed in bold.
- [Apply] and [Revert] buttons** - allow to memorize of changed parameters or revert changed but not approved (using **[Apply]**) parameters.
- [Download data (file)] button** - allows to read measurement data from files created while data downloading using USB FlashDrive. After selecting this command, user has to point location (folder with files written by data logger) containing data to download.

WARNING! The USB FlashDisk will be automatically detected if inserted to PC USB port, and the user will be asked for confirmation of data download (if any data available on the inserted disk). **[Download data (file)]** button should be used only if the logged data was previously copied from FlashDrive to PC hard drive.

- **[Download data (RS485)]** - allows to read data stored in all devices installed using RS485 interface,
- **[Add]** and **[Remove]** buttons - allow to add and remove installed devices from the system,

3.3.2...Groups” tab - group operations

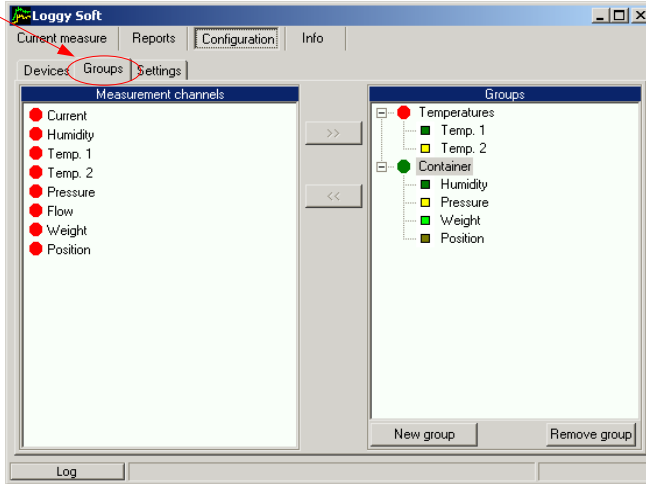

Fig. 3.14. Configuration - Groups tab

A **group** enables creating a collective current graph/report for a number of measurement channels belonging to the same or to different **PMS-90R** devices, which the user wishes to view on one graph/report. A group consists of a maximum of 12 measurement channels.

Typical methods of grouping measurement channels:

- measurement channels recording the measurements of the same physical value (e.g. temperature or humidity),
- measurement channels recording the measurements from sensors located in the same places, e.g. “Assembly room”.



One measurement channel can belong to different groups.

Creating a new group

In order to create a new group:

- click on the **[New group]** button,
- assign a name to the new group.

Removing a group

In order to remove a group:

- check the desired group on the **Groups** list,
- click on the **[Remove group]** button.

Changing group name

In order to change a group's name:

- check the desired group on the **Groups** list,
- click on the group again,
- the group name will be highlighted - the name can be edited. The edit can be cancelled (restore previous name) by pressing the **[ESC]** key. Upon completing the edit, confirm changes with **[ENTER]** key.

Adding measurement channels to a group

In order to add a measurement channel to a group:

- check the group, to which the channel is to be added (the checked group is marked with a green circle),
- then check one, or (holding down the **[Ctrl]** key) many channels of **Measurement channels** list,
- finish the procedure using the **[>>]** button.



A maximum of 12 channels can be added to one group.

Removing a measurement channel from a group

To remove a channel from a **Group**:

- find the desired group on the **Groups** list,
- show the list of devices in the group using “+” mark,
- check the measurement channel to be removed,
- finish the procedure using the **[<<]** button.

3.3.3...Settings" tab

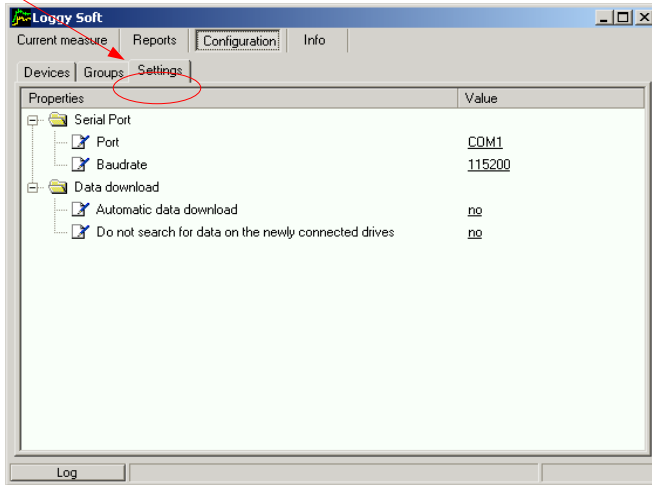

Fig. 3.15. Configuration - Settings tab

Settings tab (Fig. 3.15) allows to change settings related to serial port and method of data downloading from the USB FlashDisk. The settings list contains following fields:

- **Port field** - used to change the computer's communication port to which the converter is connected,
- **Baudrate field** - defines baud rate,
- **Automatic data download** option - enable this option causes, that files found on the connected removable flash disk (PenDrive) will be downloaded automatically without wait for user permission. To search files on removable flash disks automatically, **Automatic data search on newly connected drives** option must be enabled.
- **Do not search for data on the newly connected drives** option - disable this option, causes automatic checking if files stored on connected removable flash disk (PenDrive) contain measurement data stored by data logger. If found files has not been read, and their data are not stored in **Loggy Soft** database yet, appropriate information will be showed or data will be converted automatically (only if **Automatic data download** option is enabled).

3.4. LIST OF ERRORS AND FAULT DIAGNOSTICS

<i>Symptom</i>	<i>Cause</i>	<i>Action</i>
All points are a red colour and a question mark (?) is displayed instead of current values	converter fault or one of converter's connections is broken	<ul style="list-style-type: none">• check converter power supply• check connection of transmission line with converter• check correct operation of computer's serial port (e.g. by connecting mouse to the port supporting the converter)
Some points are a red colour (and question marks are displayed instead of current values)	Transmission line fault	<ul style="list-style-type: none">• check connections on the first transducer that "does not reply"• check continuity of transmission line from the place where the lack of communications occurred
One of the points is a red colour (and question mark is displayed instead of current value)	Transducer fault	<ul style="list-style-type: none">• check transducer connections• if the control LED flashes at high rate, then the transducer has a faulty sensor.

III. USER MANUAL FOR “S-TOOLKIT”



*designed for
Windows*

System requirements:

At least i486 computer,
Windows® 95/98/ME/2000/XP
Colour monitor with minimum resolution of 640 x 480,
1 MB of free hard drive space.

1. GENERAL CHARACTERISTICS

The **S-Toolkit** software enables configuration reading and writing operations, updating the device firmware and obtaining basic information on **PMS-90R**-type devices through RS485 serial interface. This application enables to quickly and easily define device parameters in one of three possible configuration models. The set of parameters can be transmitted directly to the device or stored in a file for future use.

2. INSTALLATION AND STARTUP

The **S-Toolkit-install** file is designed to install the program. The install file is located in **S-Toolkit** folder on CD delivered with device. During installation follow the directions provided by **Installation wizard**. The wizard will create a folder called **S-Toolkit** on the computer's hard drive, program files will be placed in this folder. The shortcut to the program will be placed in a location specified by the user.

Manual startup of the program is done using the **DLToolkit.exe** executable file. Directly after startup the program will attempt to establish communication with the device in order to read the current setup. The attempt to establish communications is executed using default (during initial program startup) settings of RS 485 port options (baud rate 9600 b/s, address 0, port: COM2) or setting defined by the user during previous launch of the program. If these settings are different than the default, or those recently used, the program will signal the communications error. After setting correct values in the **Interface options** tab, read the current configuration in **RS485 port settings** section using the **[Read from device]** button.

3. USING PROGRAM

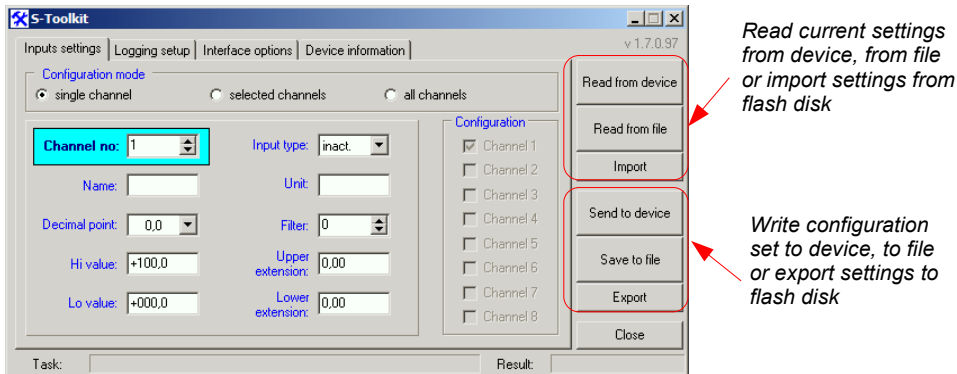

Read current settings from device, from file or import settings from flash disk

Write configuration set to device, to file or export settings to flash disk

Fig. 3.1. Program main window

There are four tabs in the central part of program window:

- **Inputs settings** - this tab enables group and individual configuration of all channels of the device;
- **Logging setup** - this tab enables defining recorded channels, type of recorded values and recording options;
- **Interface options** - this tab allows user to set RS 485 interface-related parameters, changing LCD display parameters, software and firmware language selection, and synchronizing the unit time and date with computer's time and date;
- **Device information** - this tab allows obtaining basic information about the unit and update the unit's firmware.

In the right part of the window there are six buttons:

- **[Read from device]** - reads current configuration from the device;
- **[Read from file]** - reads the configuration saved previously to a file on computer's hard drive;
- **[Import]** - imports the configuration saved previously to FlashDrive
- **[Send to device]** - saves the settings shown in the **Inputs settings** tab and writes the configuration set to the device;
- **[Save to file]** - saves the settings shown in the **Inputs settings** tab and writes the configuration set to a file on computer's hard drive;

- **[Export]** - saves the settings shown in the **Inputs settings** tab and writes the configuration set to the FlashDrive;
- **[Close]** - exits the program.

Status information concerning currently performed operation is shown in the bottom of the window.

3.1. "INPUTS SETTINGS" TAB

There are two sections in this tab:

- **Configuration mode** - select the channel configuration method in this tab. If the "**single channel**" option will be selected it will be possible to set configuration parameters for only one from the channels available in the device. "**all channels**" options enables setting configuration parameters for all channels at the same time; "**selected channels**" option enables setting configuration parameters for a number of selected channels at the same time.
- **Configuration** - this section defines, which channels are currently configured. If "**single channel**" or "**all channels**" option was checked in the "**configuration mode**" section, then selection of channels is made automatically. If "**selected channels**" option was checked in the "**configuration mode**" section, then the user can define which channels of the device he intends to configure at the moment.

For detailed description of available device configuration methods see **CONFIGURATION MODES** section.

Channel configuration method selection

Defining individual parameters of selected channels

Selecting configured channels

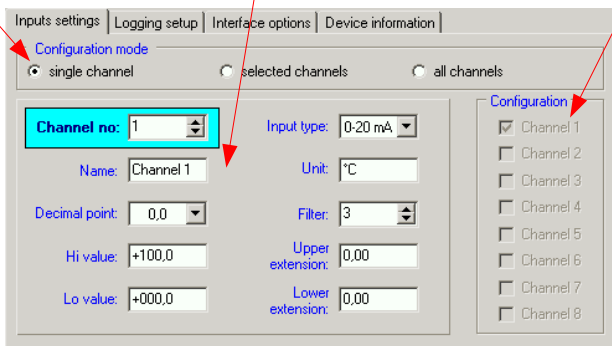

Fig. 3.2. **Inputs settings** tab options

In the central part of the tab (in a separated panel) there are fields for configuring device parameters. The parameters can be configured in three modes. Detailed description of individual parameters can be found in the user manual for device **PMS-90R**.



- The „°” (degree) sign can be entered by pressing the „~” key on the keyboard.
- The content of the list, depends on the type of device being configured.

3.2. “LOGGING SETUP” TAB

The tab contains three sections:

- **Recording** - in this section check the fields corresponding to active channels, which are to be recorded. If the selected channel is to be inactive the command to record from this channel will have no effect;
- **Averaging** - in this section check the fields corresponding to active channels of the device, for which averaged data are to be recorded instead of momentary data.
- **Logging options** - in this section define recording-related parameters for all recorded measurement channels of the device.



- “Logging setup” tab is available for devices equipped with data logging function,
- detailed description of individual parameters can be found in the user manual for data logger.

Selection of recorded channels

Defining logging options

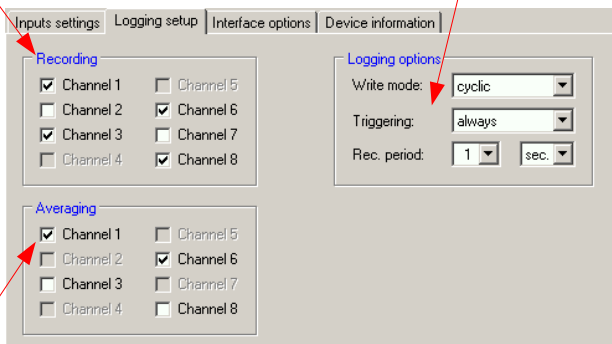

Selection of averaging for channels

Fig. 3.3. Logging setup tab options

3.3. "INTERFACE OPTIONS" TAB

This tab contains three sections:

- **RS485 port settings** - in this section define the address of configured device, transmission speed for the serial interface and the number of the serial port, to which the configured device is connected. In order for communication between the program and the device to be possible, the address and baud rate set in the program must be same as the ones set in the **PMS-90R** device.
- **Display options** - this section allows changing parameters of LCD display of configured device.
- **Language** - in this section user can select the language of **S-Toolkit** software and **PMS-90R** firmware.

There are two buttons in the lower part of the tab:

- **[Lock write to device]** - lock the possibility of writing configuration registries of the device through the RS485 interface;
-  Unlocking the possibility of writing configuration registries through the RS485 serial interface is only available from the device menu (manual configuration of device).
- **[Synchronize date and time]** - synchronizes date and time of configured device with computer's time and date.

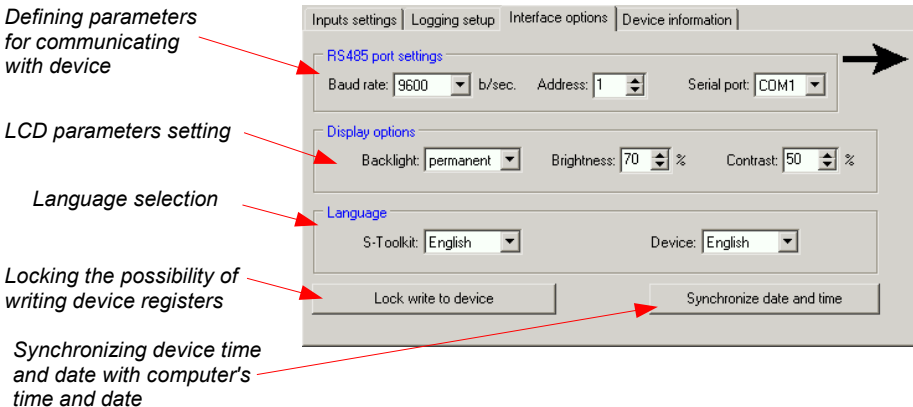

Fig. 3.4. Interface options tab functions



If the **PMS-90R** device clock shows later time than computer's system clock, then the synchronization (in this case reversing the **PMS-90R** clock) will cause all data recorded by device after the time set during synchronization to be deleted. Download the data to the computer **prior to synchronization** in order not to lose it.

Detailed description of individual parameters can be found in the user manual for device.

3.4. "DEVICE INFORMATION" TAB

This tab has three sections:

- **Device** - this section displays information concerning the device type and current version of **PMS-90R** firmware.
- **Memory** - this section displays information on the unit's memory. The **[Erase]** button irreversibly deletes memory contents. This section is available for devices equipped with data logging function.



Memory erase should be done **ONLY IN EXCEPTIONAL SITUATION!** During normal operation of device (in both mode: "cyclic" and "until full") memory erasing **IS NOT REQUIRED.**

With memory erasing all measurement results stored in memory **WILL BE DELETED!**

Erase command don't affect data actually downloaded to the PC.

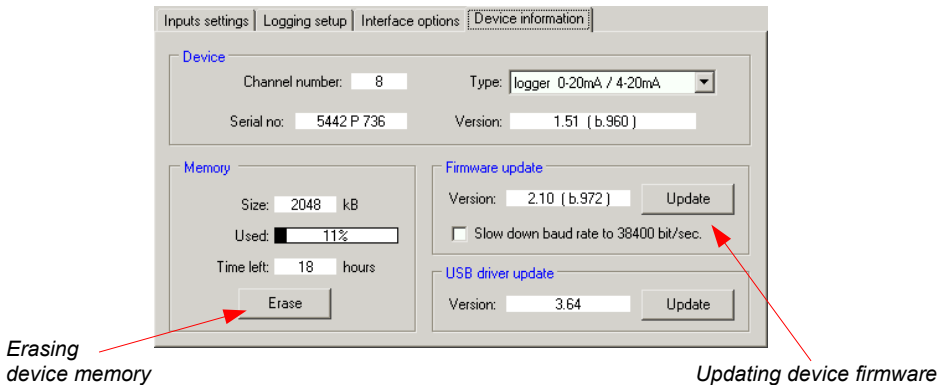

Fig. 3.5. Device information tab options

- **Firmware update** - this section allows updating the device software,
- **USB driver update** - this section allows updating the USB driver. This section is available for devices equipped with USB interface.

Detailed description of update can be found in "**UPDATING SOFTWARE OF PMS-90R DEVICE**" section.



Informations in **Device** and **Memory** sections are being updated while reading, writing or synchronizing date and time of the unit.

3.5. CONFIGURATION MODES

Depending on the option selected in **Configuration mode** section of **Inputs settings** tab three methods of configuring the device are available.



The content of the list, depends on the type of device being configured (see: description „**DEVICE INFORMATION**“)

3.5.1. Individual configuration of channels

In single channel configuration mode it is possible to change and view parameters individually for each channel. If the parameters for a given channel will be modified, then the change of number of configured channel, channel configuration method or active program tab, will result in displaying a message asking to save the settings for the recently configured channel. Confirming the save does not result in sending them to the device, it only saves the parameters shown in the **Inputs settings** tab to computer memory. If the **[Send to device]** or **[Save to file]** button is pressed after changing the parameters the program will automatically save the changed parameters without asking the user for confirmation.

3.5.2. Configuring selected channels

After switching to selected channels configuration mode, the parameters' values of most recently configured channel remain in the configuration fields. If the parameters for selected channels will be modified, then the change of channel configuration method or active program tab will result in displaying a message asking to save the settings for channels selected in the **Configuration** section (if no channel is selected the message will not be displayed). Confirming to save the parameters does not result in sending them to the device, it only saves the parameters shown in the **Inputs settings** tab to computer memory.



Settings for selected channels will be saved only after changing the configuration mode, when writing the settings to file or during transmitting the settings to the **PMS-90R** device. Therefore perform one of the aforesaid operations prior to configuring the next group of selected channels. Due to the time of writing the configuration to **PMS-90R** device it is recommended to write the set configuration to file.

3.5.3. Configuring all channels

After switching to all-channels configuration mode, the values for most recently configured channel remain in the configuration fields. Switching to the single channel configuration mode or selected channels configuration mode will result in displaying a message asking to save the settings for all channels. Confirming the save parameters does not result in sending them to the device it only saves the parameters shown in the **Inputs settings** tab to computer memory.

3.6. UPDATING SOFTWARE OF PMS-90R DEVICE

The **Firmware update** section in the **Device information** tab enables device software update. To update the software: press the **[Update]** button. During update process the application attempts to reset the unit. If the device will not reset within a few seconds, the device must be reset manually by disconnecting and reconnecting power supply. Default baud rate during device software update is 115200 bps. If transmission with this baud rate is not possible, check the Slow **down baud rate to 38400 bit/sec..**



Firmware update is possible (the **[Update]** button is active) if the updating software version is newer than the device software. In exceptional cases (update interrupted or unit does not operate after update) contact the manufacturer.

The newest version of **PMS-90R** device firmware is available at producer homepage.

The **USB driver update** section in the **Device information** tab enables USB interface driver update. To update the software: press the **[Update]** button. During update process the application attempts to write update file to the FlashDisk. After finish of the file writing put this FlashDisk (containing update file) to USB input and wait for automatic updating process finish.



Firmware update is possible (the **USB driver update** section is visible) if device is equipped with USB interface and update file version is newer than the USB driver version of the device.



APLISENS S.A. , ul. Morelowa 7

PL - 03-192 Warszawa, Poland

tel.: (+48 22) 814-07-77, fax: (+48 22) 814-07-78

<http://www.aplisens.com.pl>, e-mail: aplisens@aplisens.pl